



ZD420



Desktop Printers

User's Guide

© 2016 ZIH Corp and/or its affiliates. All rights reserved.

The copyrights in this manual, the software and/or firmware in the label printer and accessories described therein are owned by ZIH Corp. Unauthorized reproduction of this manual or the software and/or firmware in the label printer may result in imprisonment of up to one year and fines of up to \$10,000 (17 U.S.C.506). Copyright violators may be subject to civil liability.

This product may contain ZPL®, ZPL II®, and ZebraLink™ programs; Element Energy Equalizer® Circuit; E3®; and Monotype Imaging fonts. Software © ZIH Corp. All rights reserved worldwide.

ZD400 Series, ZD420, ZD420c, Link-OS, ZebraLink and all product names and numbers are trademarks, and Zebra, the Zebra logo, ZPL, ZPL II, Element Energy Equalizer Circuit, and E3 Circuit are registered trademarks of ZIH Corp. All rights reserved worldwide.

All other brand names, product names, or trademarks belong to their respective holders.

For additional copyright and trademark information, please see “Copyright” on the Zebra website.

www.zebra.com/copyright

Proprietary Statement This manual contains proprietary information of Zebra Technologies Corporation and its subsidiaries (“Zebra Technologies”). It is intended solely for the information and use of parties operating and maintaining the equipment described herein. Such proprietary information may not be used, reproduced, or disclosed to any other parties for any other purpose without the express, written permission of Zebra Technologies.

Product Improvements Continuous improvement of products is a policy of Zebra Technologies. All specifications and designs are subject to change without notice.

Liability Disclaimer Zebra Technologies takes steps to ensure that its published Engineering specifications and manuals are correct; however, errors do occur. Zebra Technologies reserves the right to correct any such errors and disclaims liability resulting therefrom.

Limitation of Liability In no event shall Zebra Technologies or anyone else involved in the creation, production, or delivery of the accompanying product (including hardware and software) be liable for any damages whatsoever (including, without limitation, consequential damages including loss of business profits, business interruption, or loss of business information) arising out of the use of, the results of use of, or inability to use such product, even if Zebra Technologies has been advised of the possibility of such damages. Some jurisdictions do not allow the exclusion or limitation of incidental or consequential damages, so the above limitation or exclusion may not apply to you.

Document Conventions

Table 1 • Document Conventions

Alternate Color

If you are viewing this guide on-line, you can click the [blue text](#) used for cross-references or hyper-links to jump directly to other sections in the guide or to web sites on the Internet.

Command Line Examples, File Names, and Directories

Command line examples, file names, and directories appear in a Typewriter style (Courier) mono-spaced font. For example:

Type `zTools` to get to the Post-Install scripts in the `/bin` directory.

Open the `Zebra<version number>.tar` file in the `/root` directory.

Icons and Advisory Words

The following icons and advisory words are used to draw your attention to certain areas of text.



Caution • Warns you of the potential for electrostatic discharge.



Caution • Warns you of a potential electric shock situation.



Caution • Warns you of a situation where excessive heat could cause a burn.



Caution • Advises you that failure to take or avoid a specific action could result in physical harm to **you**.

(No icon)

Caution • Advises you that failure to take or avoid a specific action could result in physical harm to the **hardware**.



Important • Advises you of information that is essential to complete a task.



Note • Indicates neutral or positive information that emphasizes or supplements important points of the main text.



Tools • Tells you what tools you need to complete a given task.

Contents

Document Conventions	iii
• Contents	iv
1 • Introduction	1
ZD420 Thermal Transfer Printers	1
ZD420 Printer Features:	2
ZD420 Printer Options:	3
Zebra Label Printing Solution	4
Modes of Printing	4
What's in the Box?	5
Unpack and Inspect the Printer	6
Printer Features	7
Open the Printer	8
Closing the printer.	8
Operator Controls	12
Power	12
Pause	12
Feed (Advance)	12
Cancel	13
Status	13
Pause	13
Data	13
Supplies	13
Network	14
Print Touch	15
2 • Install Hardware Options	16
Printer Connectivity Modules	16

Media Handling Options	16
Printer Connectivity Modules	17
Update Printer Firmware to Finish Option Installations	17
Accessing the Connectivity Module Slot	17
Installing the Serial Port Module	18
Installing the Internal Ethernet (LAN) Module	19
Removing Printer Connectivity Modules	20
Print Media Handling Options	21
Update Printer Firmware to Finish Option Installations	21
Cutter Option	21
Cutter Details	21
Removing the Standard Bezel	22
Installing the Label Dispenser	23
Installing the Cutter	24
Media Roll Core Size Adapters	25
Installing Media Roll Adapters	25
Printhead Upgrade Kits	27
3 • Setup	28
Printer Setup Overview	28
Select a Location for the Printer	29
Install Printer Options and Connectivity Modules	29
Attaching Power	30
Getting Ready to Print	31
Preparing and Handling Media	31
Media Storage Tips	31
Loading Roll Media	32
Instructions for media loading:	32
Using the Movable Sensor	36
Adjusting the Movable Sensor for Black Marks or Notches	36
Adjusting the Movable Sensor for Web (Gap) Sensing	37
Zebra Printer Models Fixed Sensor Position Relative to the ZD420	37
Loading Roll Media (continued)	38
Loading the Ribbon Cartridge	39
Run a SmartCal Media Calibration	40
SmartCal Procedure	40
Test Printing with the Configuration Report	41
Detecting a Media Out Condition	42
Recovering from a Media Out condition	42
Detecting a Ribbon Out Condition	43
Recovering from a Ribbon Out condition	43

Connecting your Printer to a Computer	44
Pre-install Windows® Printer Drivers	44
Interface Cable Requirements	44
USB Interface	45
Serial Interface	46
Ethernet (LAN, RJ-45)	47
Ethernet Status/Activity Indicators	47
Assigning an IP Address for Network Access	48
DHCP for Personal Networks	48
Managed Networks	48
Print Server - Default User ID and Password	48
Wi-Fi and Bluetooth Classic Wireless Connectivity Option	49
Update Printer Firmware to Finish Option Installations	49
4 • Setup for Windows OS	50
Windows Operating Systems Printer Setup (Overview)	50
Pre-install Windows® Printer Drivers	50
Setting Up the Wi-Fi Print Server Option	51
Configure Using the Connectivity Wizard	52
To use the Connectivity Wizard, complete these steps:	52
Bluetooth Option Configuration	60
Connecting to a Windows XP® SP2 Master Device	62
Connecting to a Windows Vista® SP2 or Windows 7® Master Device	63
Connecting the Printer to a Windows 8	66
Connecting the Printer to a Windows 10 PC	67
After Your Printer is Connected	69
Testing Communications by Printing	69
Test Printing with Zebra Setup Utility:	69
Test Printing with Windows 'Printer and Faxes' menu:	69
Test Print with an Ethernet printer connected to a network	69
Test Print with a Copied ZPL Command File for Non-Windows Operating Systems:	70
5 • Print Operations	71
Thermal Printing	71
Determining Your Printer's Configuration Settings	71
Replacing Supplies	72
Adjusting the Print Quality	72
Adjusting the Print Width	72
Printing on Fan-Fold Media	73
Printing with Externally Mounted Roll Media	75
Externally Mounted Roll Media Considerations:	75
Using the Label Dispenser Option	76
Sending Files to the Printer	80

Printer Fonts	80
Identifying Fonts in Your Printer	80
Localizing the Printer with Code Pages	80
Asian fonts and Other Large Font Sets	81
Getting Asian Fonts	81
Zebra® ZKDU — Printer Accessory	82
ZBI 2.0™ — Zebra Basic Interpreter	82
6 • Troubleshooting	83
Meaning of the Indicator Light Patterns	84
Printing Issues	87
Communications Problems	90
Miscellaneous Issues	91
Updating Printer Firmware	92
USB Host	93
Flash Drive Preparation and Firmware Update	94
Ribbon Cartridge Programming Commands	95
Operator Darkness Control	96
Printer Diagnostics	97
Power-On Self Test	97
SmartCal Media Calibration	97
Configuration Report (CANCEL Self Test)	98
Printer Network Configuration Report	99
Printer Bluetooth Configuration Report	100
iOS Bluetooth Support	100
Print Quality Report (FEED self test)	101
Reset Printer Factory Defaults (PAUSE + FEED Self Test)	104
Reset Network Factory Defaults (PAUSE + CANCEL Self Test)	104
Reset Button	105
Communication Diagnostics Test	106
Sensor Profile	107
Advanced Mode	109
Manual Media Calibration	109
Manual Print Width Adjustment	110
Manual Print Darkness Adjustment	111
Factory Test Modes	112
7 • Maintenance	113
Cleaning	114
Cleaning the Printhead	115
Media Path Cleaning	117
Cleaning the Cutter and Label Dispenser Options	120
Cutter	120

- Label Dispenser 120
- Sensor Cleaning 121
- Platen Cleaning and Replacement 124
- Other Printer Maintenance 127
- RTC Battery 127
- Fuses 127
- Replacing the Printhead 128
 - Printhead Removal 128
 - Replacing the Printhead 131
- A • Appendix: Interface Wiring 133**
 - Universal Serial Bus (USB) Interface 134
 - Serial Port Interface - Auto-detecting DTE and DCE 135
 - Connecting the Printer to a DTE Device 136
 - Connecting the Printer to a DCE Device 136
- B • Appendix: Dimensions 137**
- C • Appendix: Media 140**
 - Types of Thermal Media 141
 - Determining Thermal Media Types 141
 - General Media and Print Specifications 142
- D • Appendix: ZPL Configuration 144**
 - Managing the ZPL Printer Configuration 145
 - ZPL Printer Configuration Format 145
 - Configuration Setting to Command Cross-reference 146
 - Printer Memory Management and Related Status Reports 149

Introduction

This section introduces the new Zebra® ZD420 thermal transfer ribbon cartridge label printer. It describes what you get in your shipping box and provides an overview of printer features. It also includes procedures that describe how to open and close the printer and report any problems.

This user's guide provides all the information you need to operate your printer on a daily basis. Other publications are available to assist with service, network configuration and operation, printer utilities and applications, software development kits, and more. All publications are available on the Zebra Web site.

Your printer, when connected to a host computer, functions as a complete system for printing labels, tags, tickets, and receipts.

ZD420 Thermal Transfer Printers

The Zebra® ZD420 models are desktop label printers with the widest range of features and options.

- The 203 dpi (dots per inch print density) version printer provides thermal transfer printing at speeds up to 152.4 mm/s (6 ips - inches per second).
- The 300 dpi version printer provides thermal transfer printing at speeds up to 101.6 mm/s (4 ips).
- Includes ZD420 Healthcare printer models with plastics that withstand common hospital cleaning chemicals and a medical grade power supply.
- These printers support ZPL™ and EPL Zebra printer programming languages and a wide variety of options.

ZD420 Printer Features:

- Easy loading thermal transfer ribbon cartridge.
- OpenAccess™ design for simplified media loading.
- Easy, field installable media handling options.
- Supports media rolls:
 - Up to 127 mm (5 inch) outer diameter (O.D.) media rolls and
 - 12.7 mm (0.5 inch) and 25.4 mm (1 inch) inner diameter (I.D.) roll cores and additional core sizes with optional media core adapters.
- Movable Sensor provides compatibility with the widest range of media types:
 - Compatible with full or partial width black mark media.
 - Compatible with notched or slotted media.
 - Multi-center position transmissivity sensor for use with label gap/web media.
- Color-coded “touch points” for operator controls and media guides.
- Enhanced user control panel featuring three buttons and five status indicators.
- Universal Serial Bus (USB) Host Port that can be used for easy firmware upgrades.
- Universal Serial Bus (USB) 2.0 interface
- Modular Connectivity Slot for field installable 10/100 Ethernet (802.3 RJ-45) or Serial (RS-232 DB-9) interface options.
- Backwards compatibility focused technology eases printer replacement:
 - Drop in replacement of legacy Zebra desktop printers. The printer accepts both EPL and ZPL programming languages
 - Supports Link-OS virtual devices to interpret non-Zebra printer programming languages.
- On-the-fly OpenType and TrueType font scaling and import, Unicode, resident scalable font (Swiss 721 Latin 1 font), and a selection of resident bitmap fonts.
- XML-Enabled printing—allows XML communications for barcode label printing, eliminating license fees and print server hardware and lowering customization and programming costs.
- Zebra™ Global Printing Solution – supports Microsoft Windows keyboard encoding (and ANSI), Unicode UTF-8 and UTF 16 (Unicode Transformation Formats), XML, ASCII (7 and 8 bit used by legacy programs and systems), basic single and double byte font encoding, JIS and Shift-JIS (Japanese International Standards), Hexadecimal encoding, and custom character mapping (DAT table creation, font linking, and character remapping).
- Supports printer configuration via a setup utility running on mobile devices.
 - Use the printer’s Bluetooth Low Energy (LE) feature for short range communication to a variety of mobile devices. Bluetooth LE works with Zebra mobile setup utility applications to assist in printer setup, perform media calibration, and maximize print quality.
 - Zebra’s Print Touch (Near Field Communication - NFC) ‘tap’ to pair devices, access printer information, and access mobile applications.
- Zebra’s Link-OS - an open platform that connects operating systems for smart Zebra devices with powerful software apps (applications), making the devices easy to integrate, manage and maintain from any location.

- 64 MB of user accessible flash memory for storing forms, fonts, and graphics.
- On-board Real Time Clock (RTC).
- Printhead maintenance reporting enabled and customizable by the user.
- Easy tool-less replacement of printhead and platen (driver) roller.

ZD420 Printer Options:

- Healthcare printer models
 - Healthcare wipeable plastics for disinfecting and cleaning
 - IEC 60601-1 certified power supply
- Wi-Fi (802.11ac – includes a/b/g/n) and Bluetooth Classic 4.1 (3.X compatible) wireless connectivity as a factory installed option.
- Field installable connectivity modules:
 - Internal Ethernet Print Server (LAN, RJ-45 connector) — supports 10Base-T, 100Base-TX and fast Ethernet 10/100 auto-switching networks.
 - Serial (RS-232 DB-9) Port
- Field installable media handling options:
 - Label Dispenser (Peel-Off liner and present the label for the operator).
 - General purpose media cutter.
- Media Core Adapter kits for 38.1 mm (1.5 inch), 50.8 mm (2.0 inch), or 76.2 (3.0 inch) I.D. media cores.
- Field upgrade kit to change printer resolution is available. Change your printer from 203 dpi to 300 dpi - or - from 300 dpi to 203 dpi printing with these tool less upgrade kits.
- Asian Language support with printer configuration options for the large Simplified and Traditional Chinese, Japanese, or Korean character sets. Printers sold in China have the Simplified Chinese SimSun font pre-installed.
- Zebra® ZBI 2.0™ (Zebra BASIC Interpreter) programming language. ZBI allows you to create custom printer operations that can automate processes, use peripherals (i.e. scanners, scales, keyboards, Zebra® ZKDU™, etc.) all without being attached to a PC or network.

Zebra Label Printing Solution

The printer is just one of three (3) parts of a printing solution. To print, you need a printer (ZD420), compatible media (thermal transfer ribbon cartridge and thermal transfer media, or direct thermal media), and software (driver, applications or programming) to tell the printer what to do and print.

The media may be labels, tags, tickets, receipt paper, fan-fold stacks, tamper proof labels, etc.

The printer setup can not be completed without media installed. Ideally, your chosen media should be the same media used for its intended operation. Starting with your chosen media will speed the setup and deployment process.

Zebra assists you with label design and print with the free label and form design software: ZebraDesigner™ for Windows PC operating systems.

Zebra provides a complete suite of free Link-OS software applications and drivers to configure printer settings, print labels and receipts, get printer status, import graphics and fonts, send programming commands, update firmware, and download files.

The Zebra web site or your reseller will be able to help you identify media for your desired use case.

Modes of Printing

You can operate this printer in many different modes and media configurations:

- Direct thermal printing (which uses heat sensitive media to print).
- Thermal transfer printing with easy to use thermal transfer ribbon cartridge (heat and pressure transfers ink from the ribbon to media).
- Standard Tear-Off mode allows you to tear off each label/receipt (or batch print a strip of labels) after it is printed.
- Label Dispense Mode: If an optional dispenser is installed, the backing material can be peeled away from the label as it is printed. After this label is removed, the next one is printed.
- Media Cutting: If an optional media cutter is installed, the printer can cut the label liner between labels, receipt paper or tag stock.
- Stand-alone: The printer can print without being connected to a computer using the printer's auto running label form feature (programming based) or by using a data input device connected to the printer's serial port. This mode accommodates data input devices, such as scanners, weigh scales, a Zebra Keyboard Display Unit (ZKDU), etc.
- Shared network printing: Printers configured with an Ethernet (LAN) and Wi-Fi interface options include an internal print server.

What's in the Box?

After unpacking, make sure you have all parts shown below. Follow the procedures for inspecting the printer to familiarize yourself with printer parts so you can follow the instructions in this book.



Printer



USB Cable



**Printer Documentation
and User's CD**



**Power
Supply**



**Power Cord
varies by locale or region**

Printer Features

Figure 1 shows features on the outside and Figure 2 on page 9 shows features inside the media compartment of your printer. Depending on the printer model and the installed options, your printer may look slightly different.

Figure 1 • Printer Features

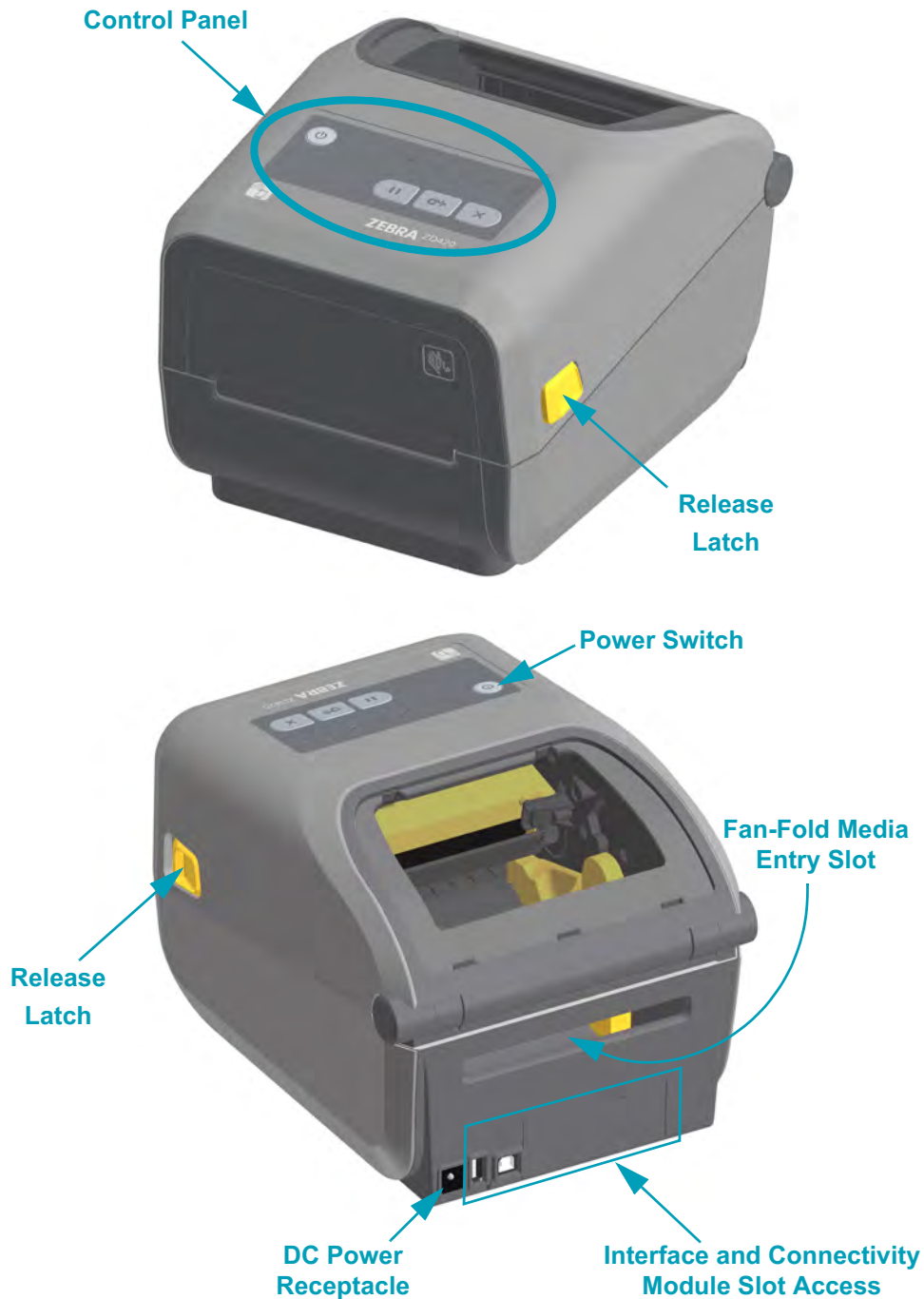

Open the Printer

To access the media compartment, you must open the printer. Pull the release latches towards you and lift the cover. Check the media compartment for loose or damaged components.

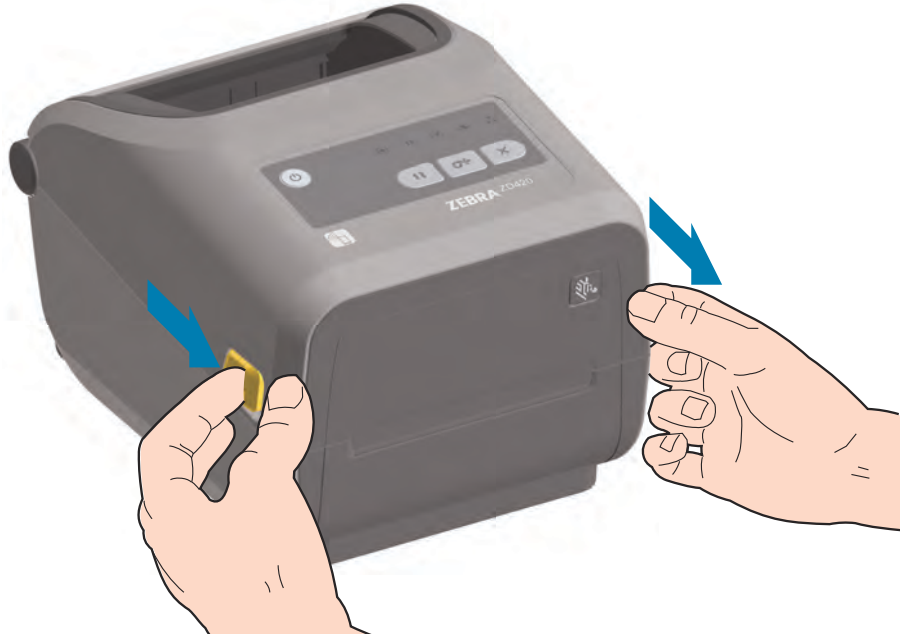

Caution • The discharge of electrostatic energy that accumulates on the surface of the human body or other surfaces can damage or destroy the printhead and other electronic components used in this device. You must observe static-safe procedures when working with the printhead or the electronic components under the top cover.

Closing the printer

Lower the top cover. Press down in the middle of the cover in front until the cover snaps closed.



Figure 2 • Printer Features - Continued

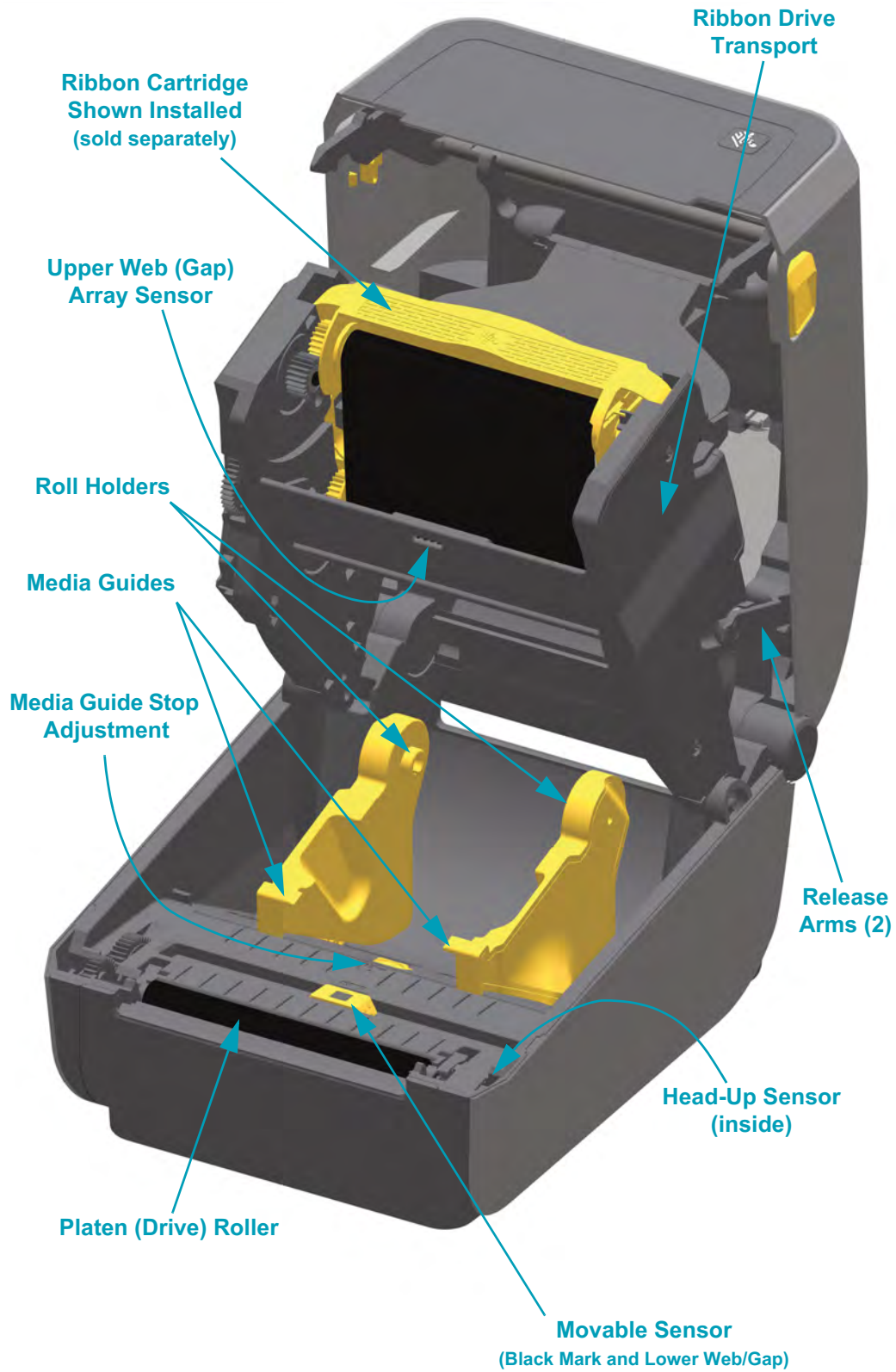
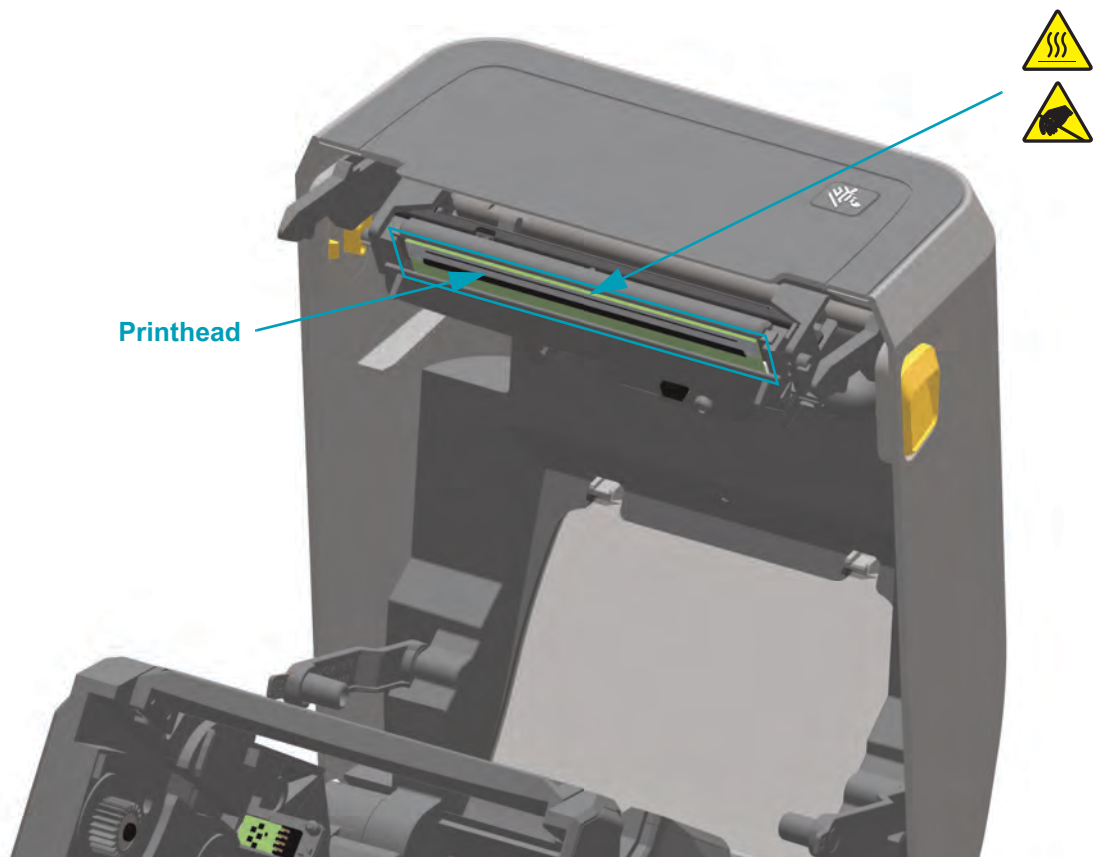

Figure 3 • Printer Features - Continued



PRINTHEAD ACCESS

- 1- Pull both release arms out
- 2- Ribbon drive transport drops
- 3- Lift printhead actuator arm up

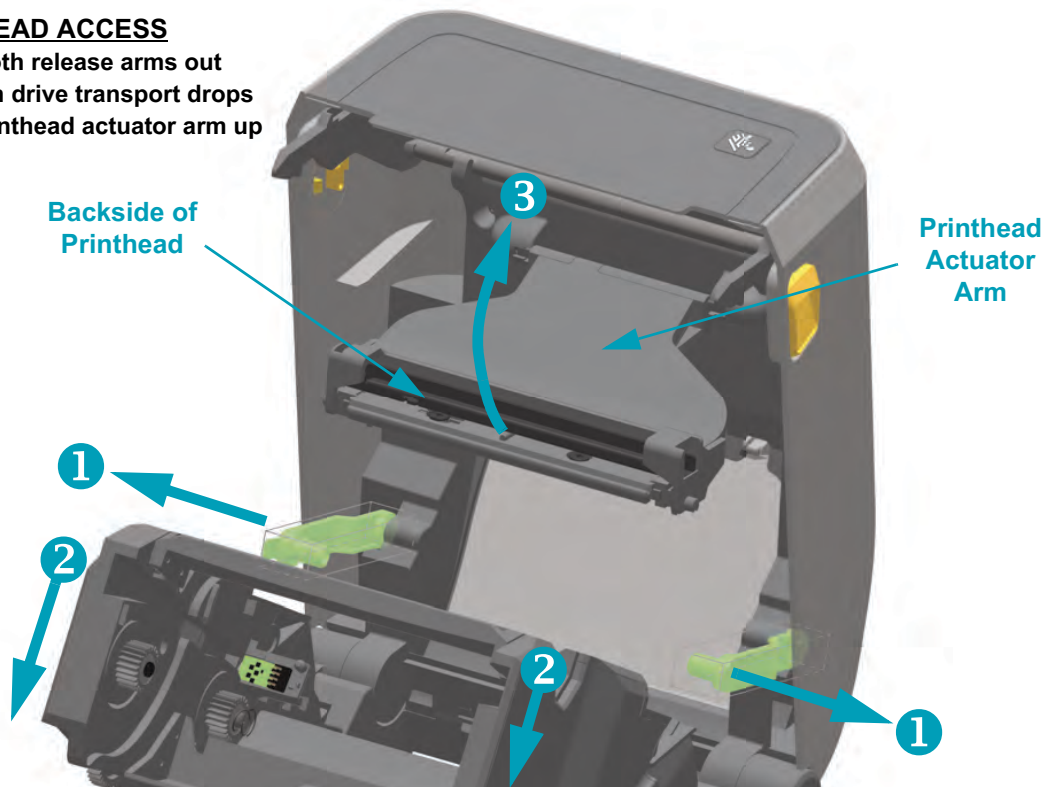

Figure 4 • Label Dispenser Option (field installable)

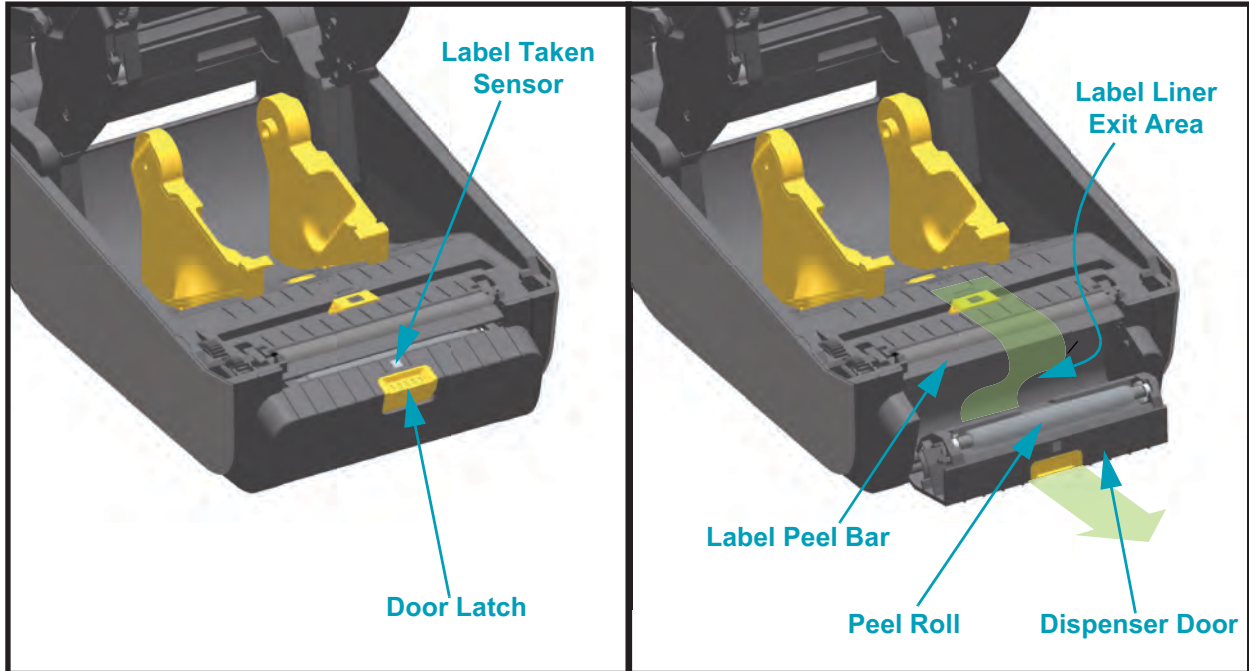
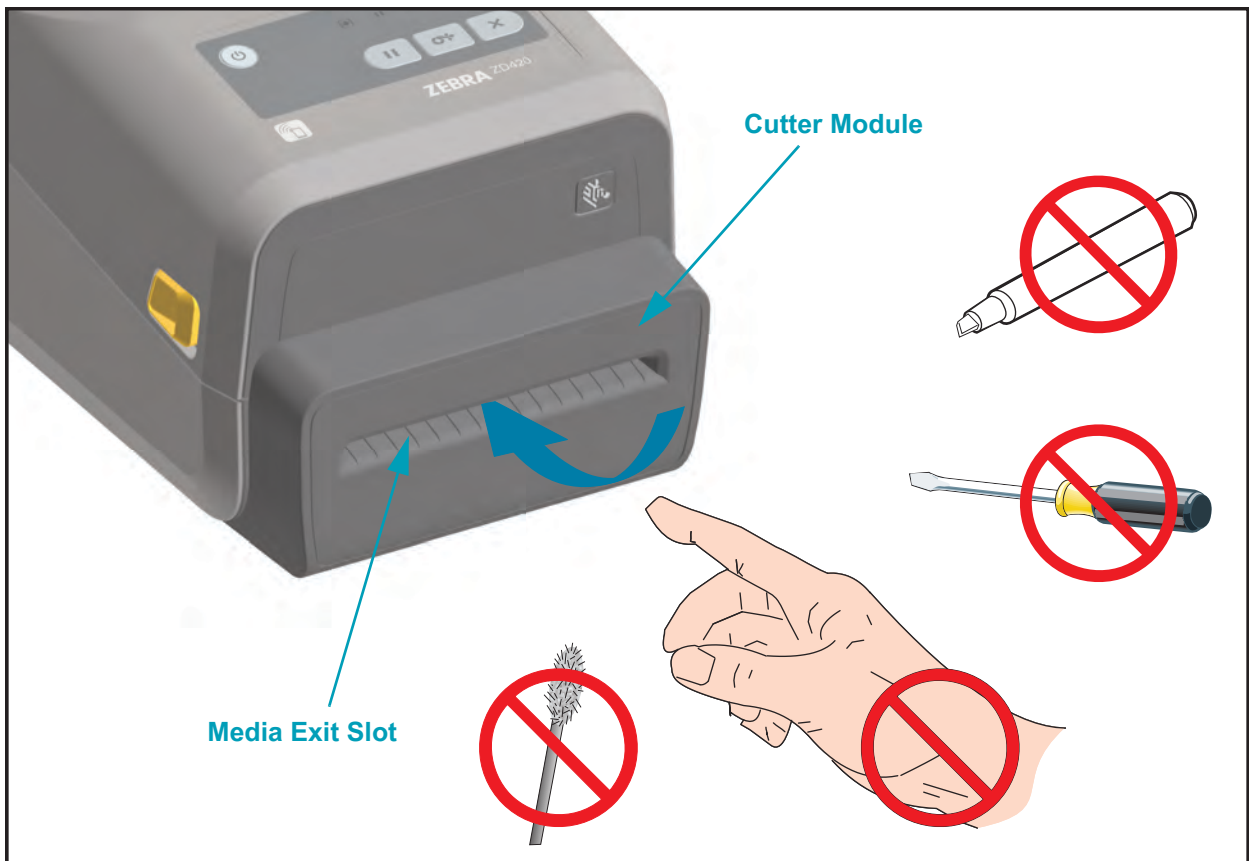
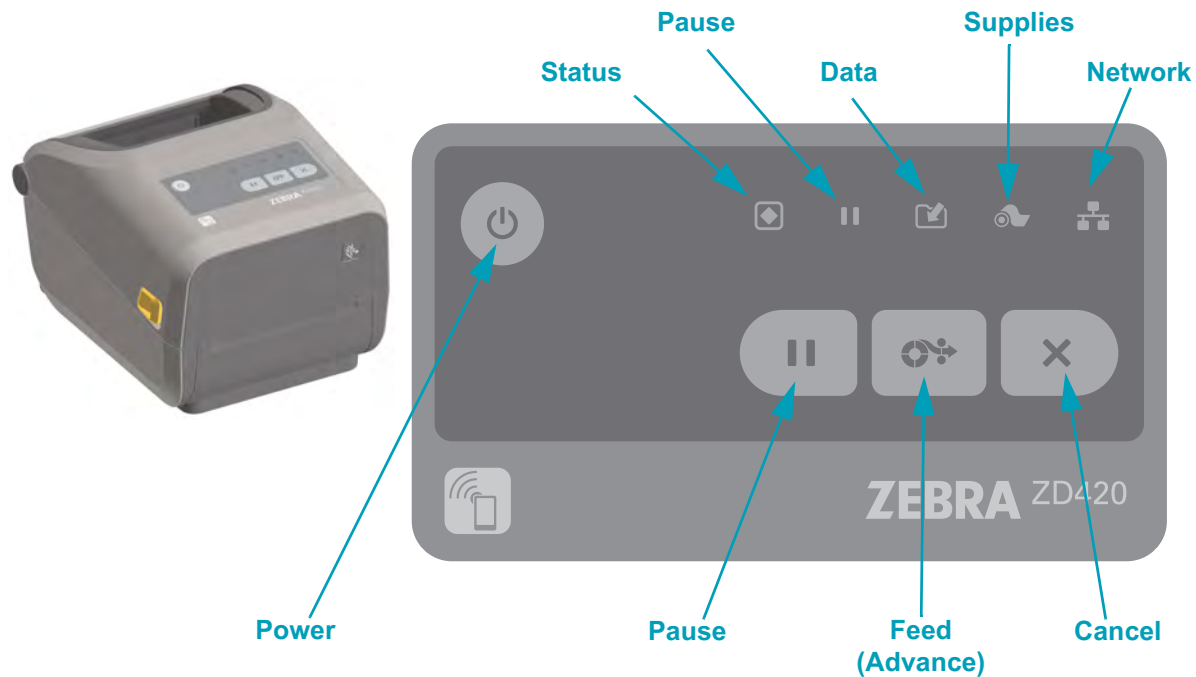

Figure 5 • Cutter Option (field installable)



Operator Controls

The primary operator controls are found on the front of the printer. The indicators may be off (not lit), red, green, or yellow. The indicators can blink or remain on in a variety of patterns that denote various printer activities or status. For more information on the indicator light patterns see [Meaning of the Indicator Light Patterns on page 84](#)).



Power

- **ON** - Press the Power button until the printer's indicator lights flash on. The printer's indicator lights will flash on and off in various combinations while the printer does internal self diagnostics and configuration checks which will take several seconds to complete.

The Status indicator will turn GREEN for PRINTER READY status, indicating the printer is now ready for normal print operations.

- **OFF** - Press and hold the Power button for three (3) seconds and the printer will turn off after (quickly) storing some configuration and status information.

Pause

- Pressing the Pause button will stop print activities and place the printer into Pause state. The printer will complete any print operation before it stops.
- The Pause indicator will display Yellow to indicate Pause state.
- Pressing the Pause button while in Pause state will return the printer to normal operation.

Feed (Advance)

- Pressing (and releasing) the Feed button when the printer is not printing, causes the printer to advance media one (1) blank form length (label, receipt, tag, ticket, etc.).



Cancel

- Only functional when the printer is in the Pause state.
- Pressing the Cancel button causes the printer to cancel printing the next format in the print buffer.
- Pressing and holding for two seconds cancels printing of ALL pending formats.



Status

- **Green:** Ready for print and data activity.
- **Red:** Media out, media detection error, head (cover) open, cutter jam, printhead authentication failure.
- **Yellow:** Printhead over temp **, printhead element failure, out of memory while storing content (formats, graphics, fonts, etc.), and interface power fault for USB Host or Serial ports.
- **Blinking Yellow:** Printhead under temp.
- **Blinking Red:** Printhead over temp**



Pause

- **Yellow:** The printer is paused. Print, label feed (advance), and other label routines are suspended until the pause state is removed by pressing the Pause button.
- **Blinking Red:** Printhead over temp**



Data

- **Off:** Data is not being transferred.
- **Green:** A data communication operation has not finished, but is not actively being transferred.
- **Blinking Green:** Data communications are in process.
- **Blinking Yellow:** Out of memory while storing content (formats, graphics, fonts, etc.).



Supplies

- **Red:** There is a media out condition.
- **Blinking Red:** Ribbon Out
- **Blinking Red and Yellow:** Ribbon Low.
- **Blinking Yellow:** Ribbon In while printer is in direct thermal mode (heat only, no ribbon).

** - **Blinking red Status and Pause** indicators for a critical over temperature of printhead - requires cooling and printer restart.



Network

- **Yellow:** 10 base Ethernet (LAN) connection detected
- **Green:** 10/100 Ethernet (LAN) connection detected or when Wi-Fi (WLAN) has a strong signal and is connected
- **Red:** when an Ethernet (LAN) or Wi-Fi (WLAN) fault occurs
- **Blinking Red:** during Wi-Fi (WLAN) association
- **Blinking Yellow:** during Wi-Fi (WLAN) authentication
- **Blinking Green:** when Wi-Fi (WLAN) has completed, but has a weak signal

Print Touch

The Zebra Print Touch™ feature allows you to touch an Android™ -based, Near Field Communication (NFC)-enabled device such as a smart phone or tablet to the printer's Print Touch logo to pair the device to the printer. This capability allows you to use your device to provide information for which you are prompted and then print a label using that information.



Important • Some devices may not support NFC communication with the printer until you configure the required NFC settings in your device. If you encounter difficulties, consult your service provider or your smart device manufacturer for more information.

Data encoded into the tag includes:

- A URL for a Zebra QuickHelp style support web page
- The printer's unique Bluetooth Low Energy MAC address
- The printer's Bluetooth Classic MAC address (if present)
- The printer's Wi-Fi (WLAN) MAC address (if present)
- The printer's Ethernet (LAN) MAC address (if present)
- The printer SKU – ex. ZD42022-D01W01EZ
- The printer's unique serial number

The NFC tag can be used to:

- Facilitate Bluetooth pairing with a compatible mobile device
- Launch an application
- Launch a mobile browser to a web page



Install Hardware Options

This section assists you in installing printer connectivity modules and media handling options.



Note • Install your connectivity module or media handling options prior to setting up and using your printer for the first time. This will simplify and speed up the setup process. During the initial setup, do not connect the printer to power until all printer hardware options have been installed.

Printer Connectivity Modules

The connectivity module's access door must be removed ([Accessing the Connectivity Module Slot on page 17](#)) prior to installing the following options:

- Serial (RS-232 DB-9) Port - [Installing the Serial Port Module on page 18](#)
- Internal Ethernet (LAN, RJ-45 connector) — supports 10Base-T, 100Base-TX and fast Ethernet 10/100 auto-switching networks - [Installing the Internal Ethernet \(LAN\) Module on page 19](#)

Media Handling Options

The printer's standard bezel must be removed ([Removing the Standard Bezel on page 22](#)) prior to installing the following options:

- Label Dispenser (Peel-Off Liner and Present Label for Operator) - [Installing the Label Dispenser on page 23](#)
- General purpose media cutter - [Installing the Cutter on page 24](#)
- 203 dpi and 300 dpi Printer Resolution Upgrade Kit - [Printhead Upgrade Kits on page 27](#)
- Media Roll Adapters for 38.1 mm (1.5 inch), 50.8 mm (2.0 inch), or 76.2 (3.0 inch) I.D. media cores.



Note • For best printer performance, update the printer's firmware after installing options or immediately after the printer's initial setup. See [Updating Printer Firmware on page 92](#).

Printer Connectivity Modules

The connectivity modules can be easily installed without tools.



Caution • The discharge of electrostatic energy that accumulates on the surface of the human body or other surfaces can damage or destroy the printhead or electronic components used in this device. You must observe static-safe procedures when working with the printhead or the electronic components.

Update Printer Firmware to Finish Option Installations

It is recommended that you always update the printer's firmware with the latest version for optimal printer operation. For instructions on how to update printer firmware, see [Updating Printer Firmware on page 92](#). This is located on the Zebra Web site at:

<http://www.zebra.com/support>

Accessing the Connectivity Module Slot

1. Open the module access door by pushing down on the top of the door with your finger tip. This releases the latch. Pull the door away and down to remove.

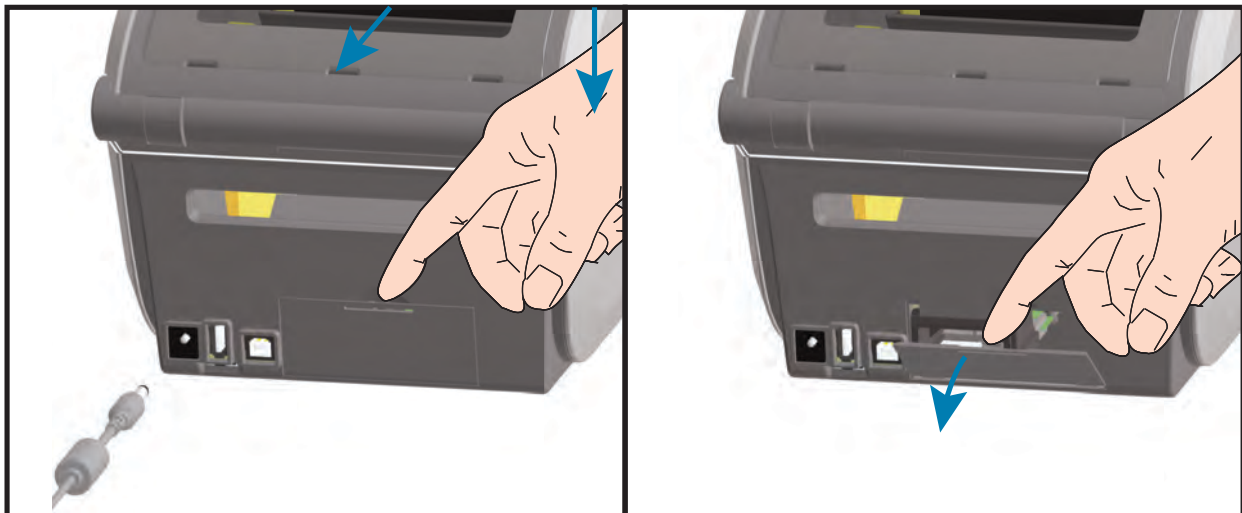

Installing the Serial Port Module



1. With the module's access door removed, slide the serial port module into the printer. Push the circuit card in slowly but firmly until the card is just past the inside lip of the access door.
2. Align the bottom of the serial port's door cover to the bottom lip of the module access opening. Swing the door up and snap the cover closed.



Installing the Internal Ethernet (LAN) Module

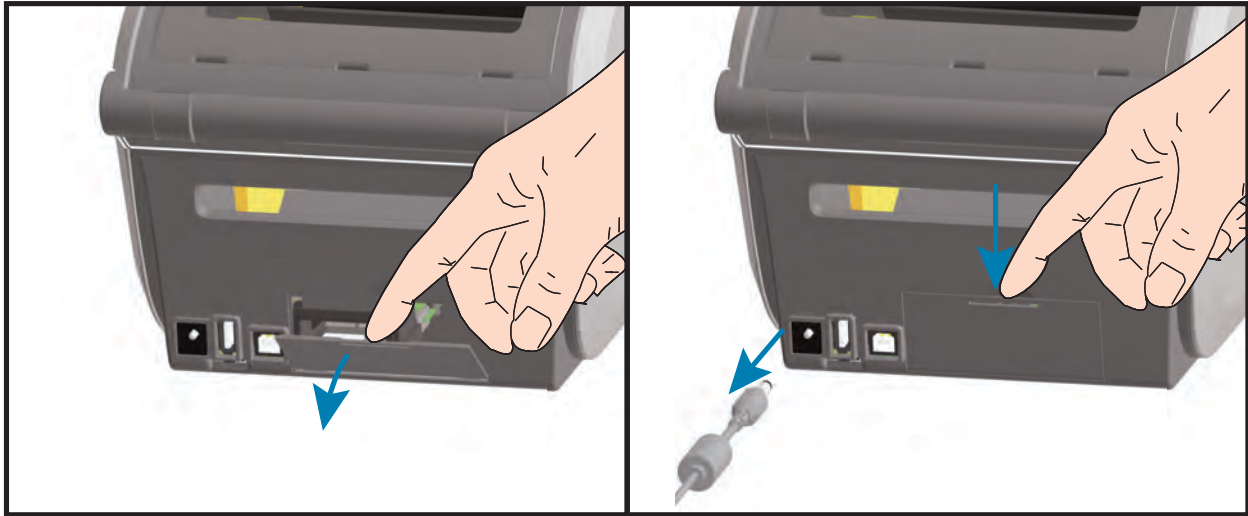

1. With the module's access door removed, slide the Ethernet module into the printer. Push the circuit card in slowly but firmly until the card is just past the inside lip of the access door.
2. Align the bottom of the Ethernet port's door cover to the bottom lip of the module access opening. Swing the door up and snap the cover closed.

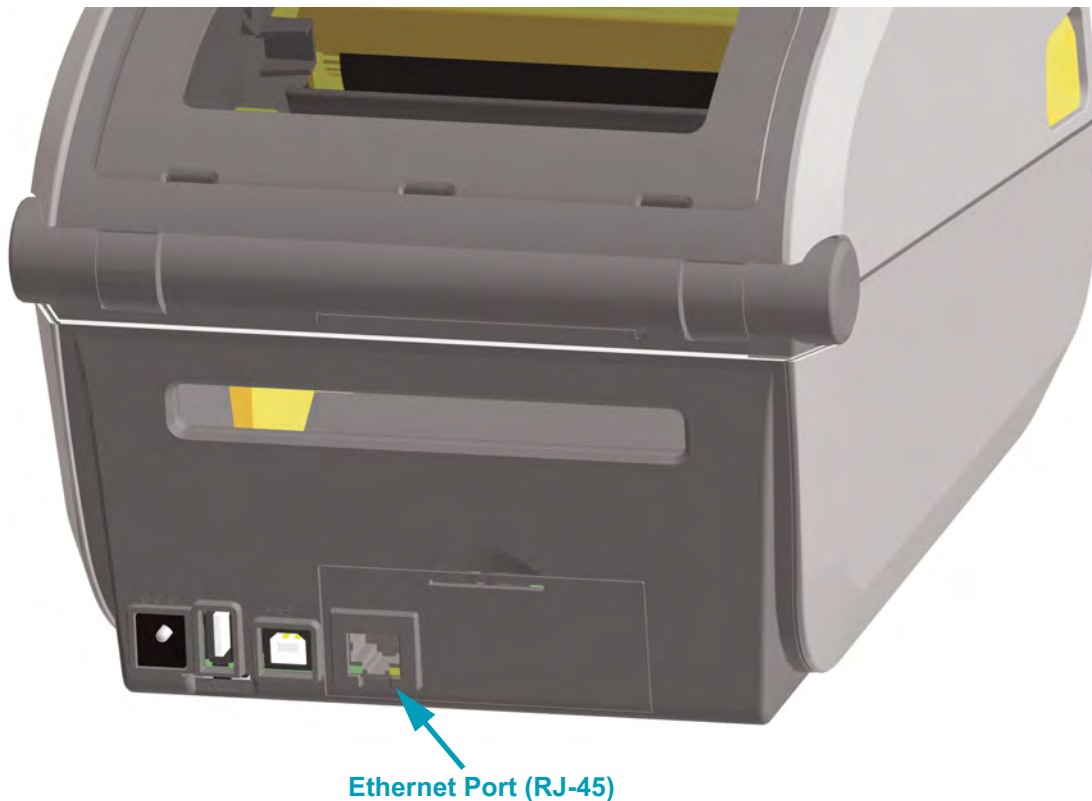

Removing Printer Connectivity Modules

Connectivity modules can easily be removed for the purpose of reconfiguring a printer or repair. You should not remove and replace connectivity modules as a general practice.

1. Remove the interface cable (Ethernet or Serial).
2. Remove the module access door. Push down on the top of the door with your finger tip. This releases the latch. Pull the door away and down to remove.
3. Re-attach the interface cable to the connectivity module and secure the cable.
4. Gently pull on the interface cable that is secured to the connectivity module. Slowly pull the module out of the printer.
5. Install a different connectivity module or re-install the connectivity module's access door. Align it to the bottom lip of the access opening and swing it up to snap and lock in place.

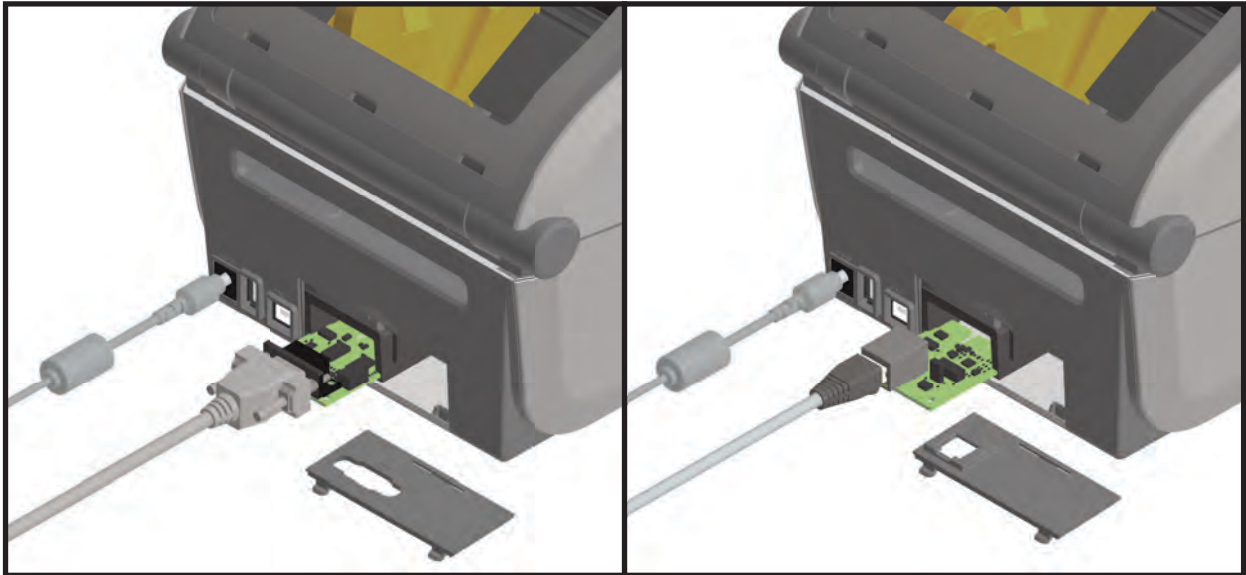

Print Media Handling Options

The media handling options and access are secured to the printer by two (2) Torx T10 screws located on the bottom of the printer. A Torx Allen type wrench is provided with the kits.



Caution • The discharge of electrostatic energy that accumulates on the surface of the human body or other surfaces can damage or destroy the printhead or electronic components used in this device. You must observe static-safe procedures when working with the printhead or the electronic components.

Update Printer Firmware to Finish Option Installations

It is recommended that you always update the printer's firmware with the latest version for optimal printer operation. This is located on the Zebra Web site at: <http://www.zebra.com/support>

Cutter Option

The printer supports a factory installed media cutter option for full width cutting of label liner, tag or receipt media. These cutter options are all supported in a single cutter housing design. The type of cutter option installed in your printer can be verified by printing a printer configuration report.

Cutter Details

- **A medium duty cutter** for cutting label liner and light tag media (LINER/TAG)
- **Paper Thickness:** 0.08 mm (0.003 inch) min. to 0.1905 mm (0.0075 inch) max.
- **Cut Width:** 15 mm (0.585 inches) minimum to 118 mm (4.65 inches) maximum
- **Minimum distance between cuts (label length):** 25.4 mm (1 inch). Cutting shorter media lengths between the cuts may cause the cutter to jam or error.
- By default, the cutter operations include a self cleaning preventive maintenance cleaning cut after every twenty-fifth cut. This feature can be disabled via a SGD (Set/Get/DO) programming command (cutter.clean_cutter) but is not recommended.



Warning • There are no operator serviceable parts in the cutter unit. Never remove the cutter cover (bezel). Never attempt to insert objects or fingers in to the cutter mechanism.

Tools, cotton swabs, solvents (including alcohol), etc. all may damage or shorten the cutter's usable life or cause the cutter to jam.

Removing the Standard Bezel

The standard bezel must be removed to mount your media handling option.

1. Turn the printer upside down. Remove the two (2) mounting screws the Torx wrench. Save the screws.
2. Slide the bezel down the front about 12.5 mm (0.5 inch) and pull the loose bezel out.

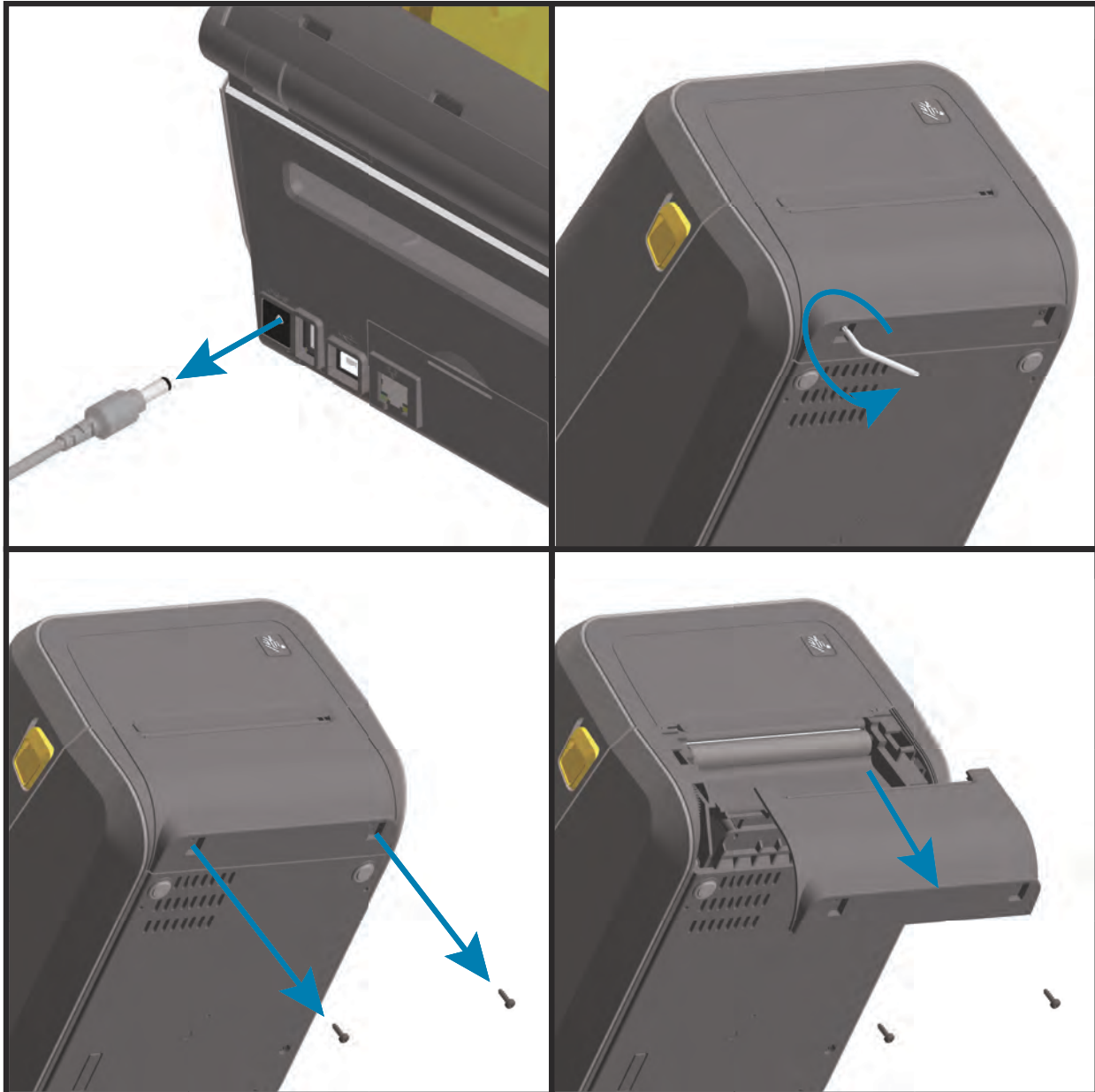

Installing the Label Dispenser

The standard bezel must be removed before the Label Dispenser can be installed.

1. Place the Label Dispenser module and printer right side up with the top of the module 12.5 mm (0.5 inch) below the bottom of the top cover. Center and push the module into the front of the printer and slide it up until it stops.
2. Turn the printer upside down and attach the module to the printer with the two screws.

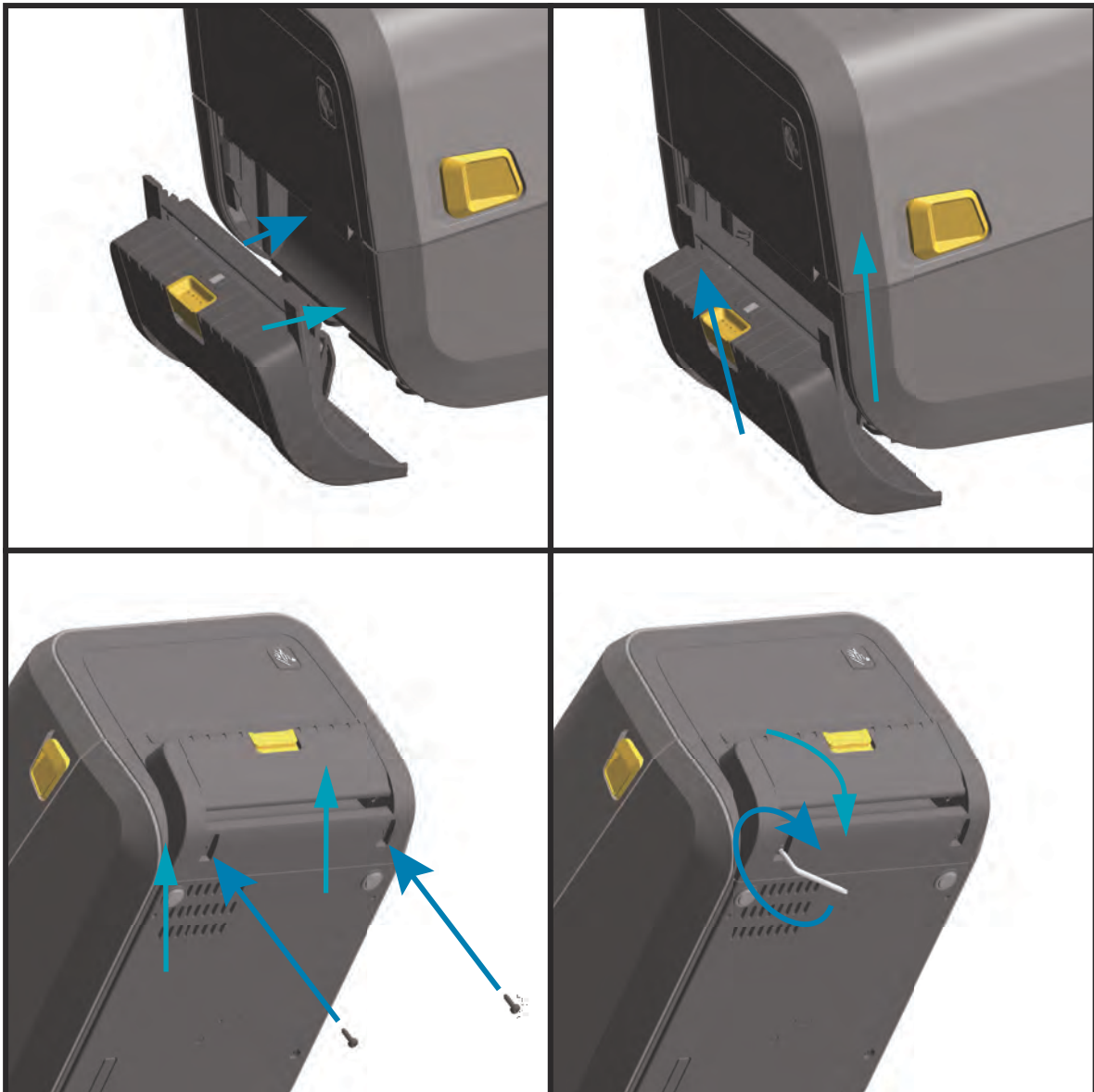

Installing the Cutter

The standard bezel must be removed before the cutter module can be installed.

1. Place the Cutter module and printer right side up with the top of the module even with the bottom of the top cover. Center and push the module into the front of the printer and slide it up until it stops.
2. Turn the printer upside down and attach the module to the printer with the two screws using the Torx wrench.

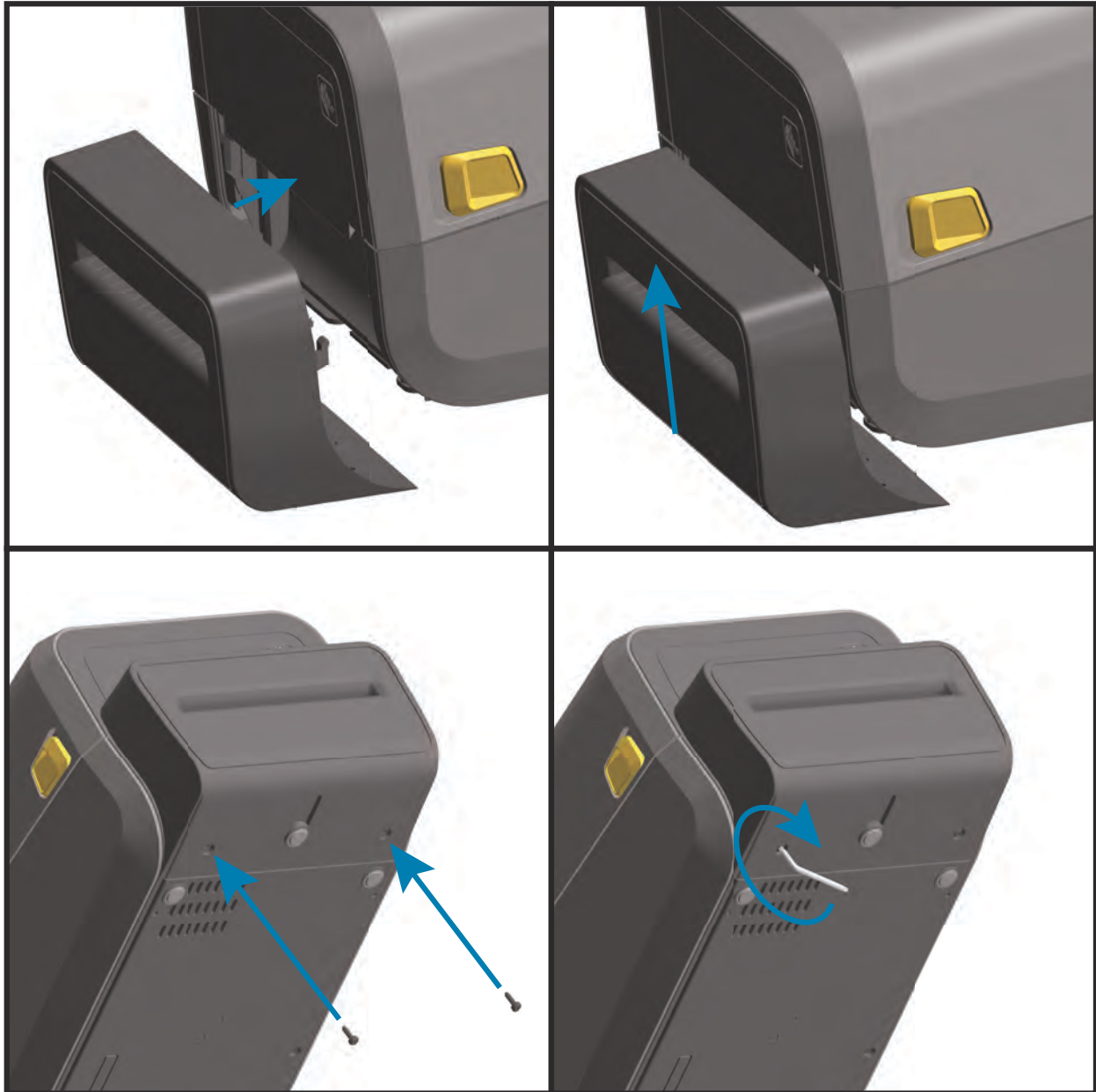

Media Roll Core Size Adapters

The media roll adapters kit includes three (3) pairs of media roll adapters. The kits are for 38.1 mm (1.5 inch), 50.8 mm (2.0 inch), or 76.2 (3.0 inch) inner diameter (I.D.) media cores.

The adapters are intended to be permanently installed in the printer. They may be changed to support other media roll sizes that require one of these adapter sizes. The adapters may wear out if they are changed too much.

Removing the media adapters to print on standard roll cores may leave plastic pieces in the media roll holders side areas that rub against the roll. Push those attached pieces back into the side of the media roll holder.

Installing Media Roll Adapters

1. Place one screw in the top adapter mounting hole of both of the roll holders. Start turning the screws clockwise using the Torx wrench until the tip of the screw is just protruding through the inside of the roll holder. The screws are self-tapping.

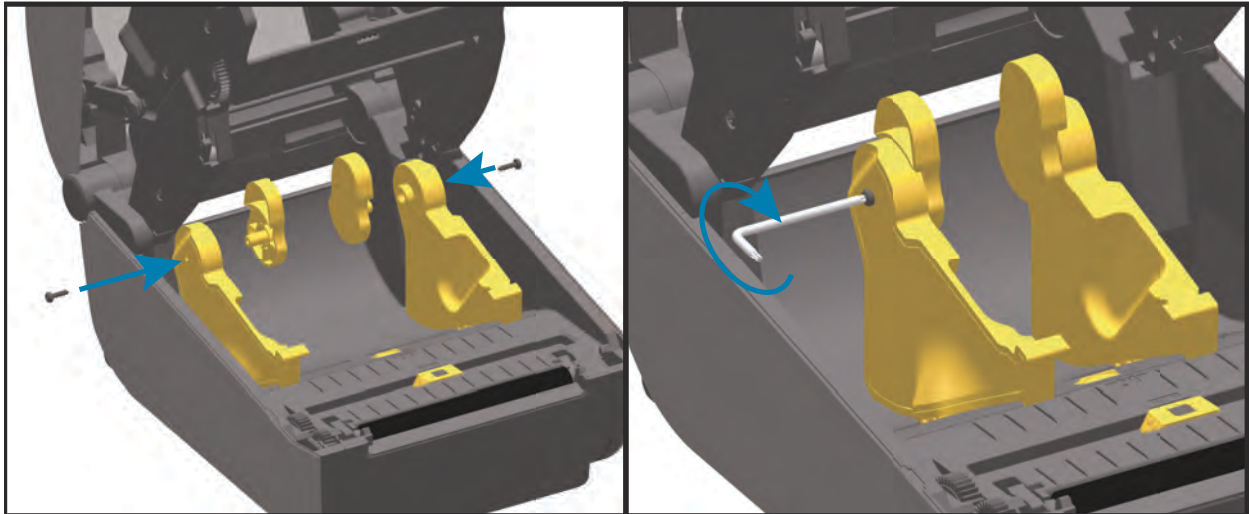

2. Place the adapter on the inside of the roll holder. The large side of the adapter is on top. The smooth side (no ribs) faces the middle of the printer.
3. Align the adapter's top screw hole to the protruding screw tip and pinch it tightly to the roll holder body. Tighten the screw until there is no gap between the adapter and roll holder. Do not tighten beyond this point. Over tightening will strip the thread.
4. Insert a screw in the bottom adapter mounting hole. Pinch the adapter tightly to the roll holder while tightening the screw. Tighten the screw until there is no gap between the adapter and roll holder. Do not tighten beyond this point. Over tightening will strip the thread.
5. Repeat step 1-4 for the other adapter and roll holder.

Example of Label Roll with
76.2 mm (3.0 inch) Inner Core
and Media Core Adapters
Attached

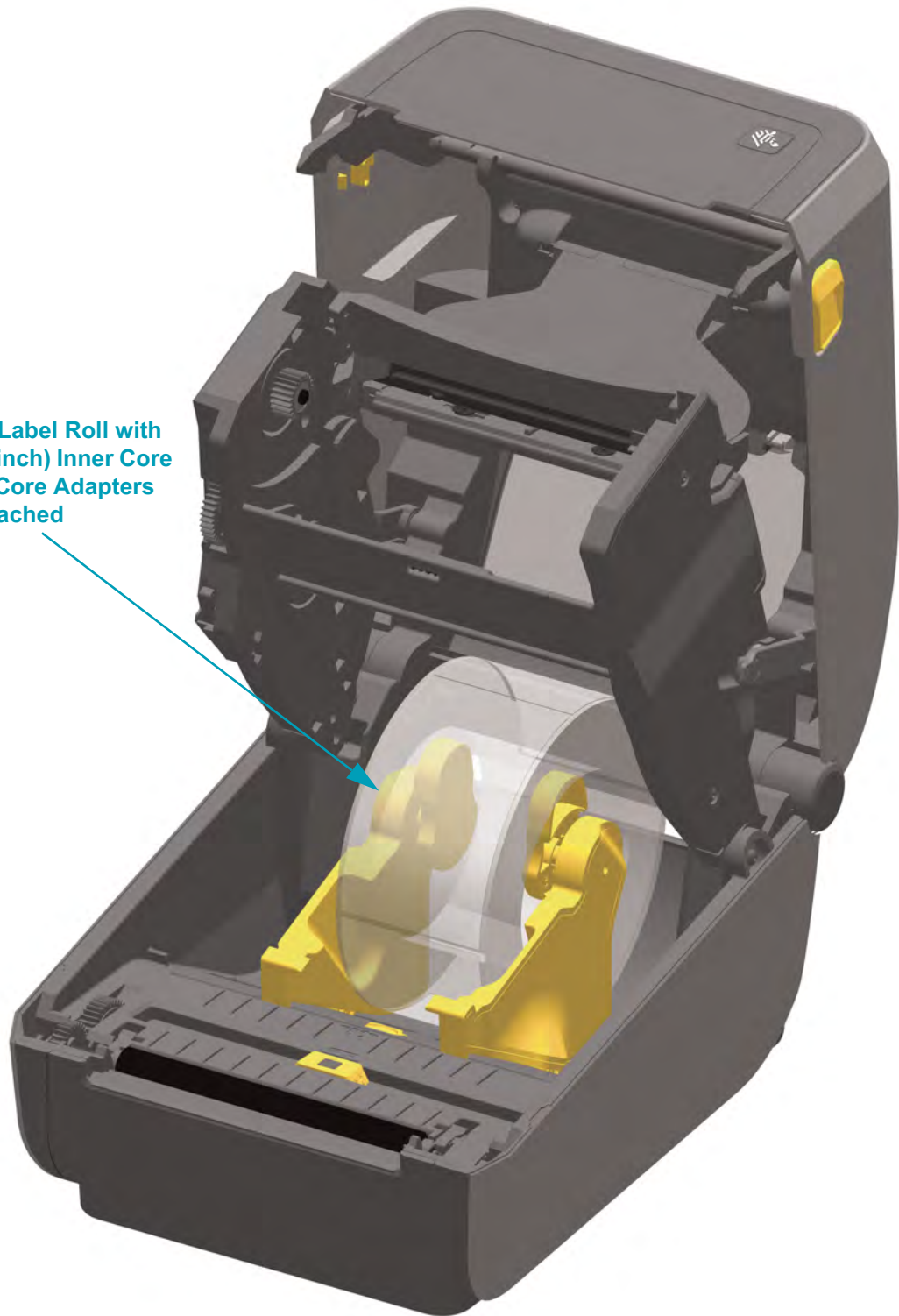

Printhead Upgrade Kits

There are two (2) printhead upgrade kits. There is one to change the printer from 203 dpi to 300 dpi printing and a second kit to change the printer from 300 dpi to 203 dpi printing.

The same procedures are used to change the printer between 203 and 300 dpi printing. The printhead and platen (drive) rollers must be changed. The printer automatically detects the change in printheads and the platen roller materials are black (203 dpi) and gray (300 dpi).



The printheads used in the upgrade kits include a 203 or 300 marking for to help you keep the unpackaged upgrade printhead separate from the original printhead. The original printhead contains no marking identifying its print resolution.

1. Turn the printer off and disconnect the power.
2. Use the procedure, [Platen Cleaning and Replacement on page 124.](#), to replace the platen roller.
3. Use the procedure, [Replacing the Printhead on page 128](#), to replace the printhead.
4. Re-attach power and turn the printer on. The printer will automatically detect the change in printhead (but not the platen) when the printer verifies the printers configuration.

For best results and the latest printer features and operation, download and install the latest printer firmware. See [Updating Printer Firmware on page 92](#).

This section assists you in setting up and operating your printer for the first time.

Printer Setup Overview

The setup process can be broken down into two (2) phases: hardware setup and host system (software/driver) setup. This section covers the physical hardware setup to print the first label.

- Install any printer hardware options first. See [“Install Hardware Options” on page 16](#).
- Place the printer in a safe location with access to power and where it can connect wired or wirelessly to the printer to the host system.
- Attach the printer and power supply to a grounded AC power source.
- Select and prepare media for your printer.
- Load the media.
- Turn the printer ON. Calibrate the media with a SmartCal Media calibration.
- Print a ‘Configuration Report’ to verify basic printer operation.
- Turn the printer OFF.
- Choose method to communicate via a wired or wireless connection to your printer. Available wired local connections are:
 - USB port
 - Optional Serial port
 - Optional Ethernet (LAN)
- Attach the printer cable to the network or host system (printer OFF).
- Begin second phase of printer setup - Software based configuration for either wired or wireless communication methods typically needed for operating systems like Microsoft Windows.

Select a Location for the Printer

The printer and media need a clean safe area with moderate temperatures to have optimal print operations.

Select a location for the printer that meets these conditions:

- **Surface:** The surface where the printer will be located must be solid, level, and of sufficient size and strength to hold the printer with media.
- **Space:** The area where the printer will be located must include enough space for opening the printer (media access and cleaning), and for printer access to connectivity and power cords. To allow for proper ventilation and cooling, leave open space on all sides of the printer.



Caution • Do not place any padding or cushioning material under or around the base of the printer because this restricts air flow and could cause the printer to overheat.

- **Power:** Put the printer close to an easily accessible power outlet.
- **Data communication interfaces:** Please ensure that cabling and Wi-Fi or Bluetooth radios do not exceed the maximum distance specified by the communication protocol standard or product data sheet for this printer. Radio signal strength can be reduced by physical barriers (objects, walls, etc.).

Data cables should not be routed with or near power cords or conduits, fluorescent lighting, transformers, microwave ovens, motors or other sources of electrical noise and interference. These interference sources may cause problems with communications, host system operation, and printer functionality.

- **Operating conditions:** Your printer is designed to function in a wide range of environments. [Table 1](#) shows the temperature and relative humidity requirements for the printer.

Table 1 • Operational and Non-Operational Temperature and Humidity

Mode	Temperature	Relative Humidity
Operational	32° to 104°F (0° to 40°C)	20 to 85% non-condensing
Non-Operational	-40° to 140°F (-40° to 60°C)	5 to 85% non-condensing

Install Printer Options and Connectivity Modules

Install the following printer options before proceeding with the printer's setup.

- Serial (RS-232 DB-9) Port Module - [Installing the Serial Port Module on page 18](#)
- Internal Ethernet (LAN) Module - [Installing the Internal Ethernet \(LAN\) Module on page 19](#)
- Label Dispenser (Peel-Off Liner and Present Label for Operator) - [Installing the Label Dispenser on page 23](#)
- General purpose media cutter - [Installing the Cutter on page 24](#)
- 200 and 300 dpi Printer Upgrade kits -See ["Printhead Upgrade Kits" on page 27](#).
- Media Core Adapter kit for 38.1 mm (1.5 inch), 50.8 mm (2.0 inch), or 76.2 (3.0 inch) I.D. media cores. [Media Roll Core Size Adapters on page 25](#)

Attaching Power



Important • Set up your printer so that you can handle the power cord easily if needed. To make certain the printer cannot carry electrical current, you must separate the power cord from the power supply receptacle or AC electrical outlet.



Caution • Never operate the printer and power supply in an area where they can get wet. Serious personal injury could result!

1. Plug the power supply into the printer's DC power receptacle.
2. Insert the AC power cord into the power supply.
3. Plug the other end of the AC power cord into an appropriate AC electrical outlet. Note that AC outlet end of the power cord's plug type can vary by region.
4. The active power light will turn on green if power is on at the AC outlet.

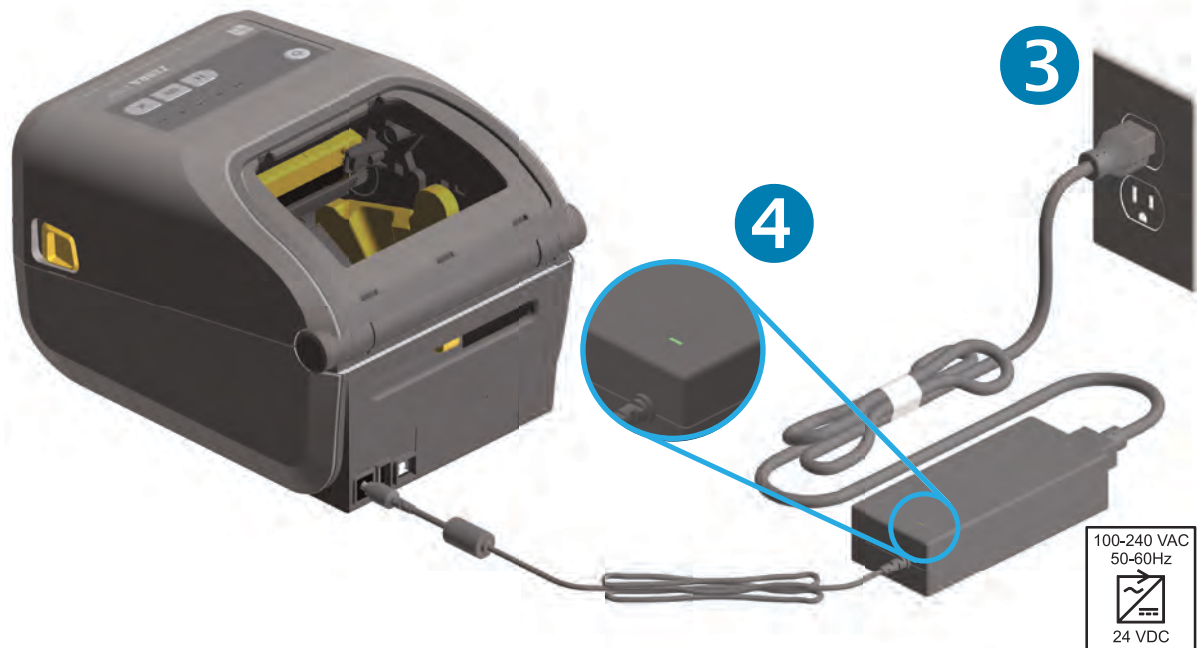
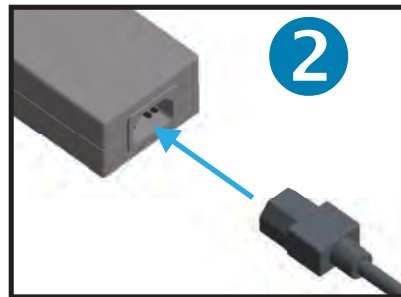

Note • Ensure the appropriate power cord with a three (3) prong plug and an IEC 60320-C13 connector are used at all times. These power cords must bear the relevant certification mark of the country in which the product is being used.

Getting Ready to Print

The printer setup cannot be completed without media. The media may be labels, tags, tickets, receipt paper, fan-fold stacks, tamper proof labels, etc. Ideally, your chosen media should be the same media used for its normal intended operation. This will help you more easily identify any setup issues while using this guide. The printer does not come with media.

The Zebra web site or your reseller may be able to help you select the right media for your intended printing application.

Preparing and Handling Media

Careful handling and storage of your media is important in order to maximize print quality. If the media becomes contaminated or dirty, it can damage the printer and cause defects in the printed image (voids, streaks, discoloration, compromise the adhesive, etc.).

During manufacturing, packaging, handling and storage, the outside length of media may become dirty or contaminated. We recommend removing the outside layer of the media roll or stack. This will remove any contaminants which might be transferred onto the printhead during normal operation.

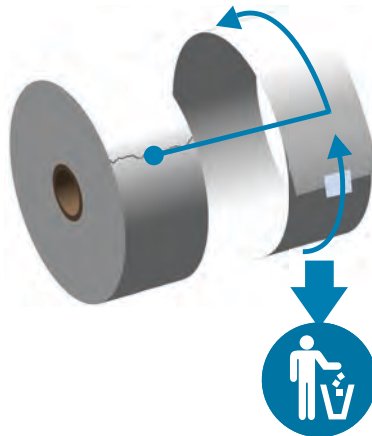

Media Storage Tips

- Store media in a clean, dry, cool, dark area. Direct thermal media is chemically treated to be heat sensitive. Direct sunlight or heat sources may 'expose' the media.
- Do not store media with chemicals or cleaning products.
- Leave media in its protective packaging until it is to be placed in the printer for use.
- Many media types and label adhesives have a 'shelf life' or expiration date. Always use the oldest, viable (non-expired) media first.

Loading Roll Media

The printer utilizes two (2) sensing methods to accommodate a wide range of media

- Center area transmissive sensing for continuous media and gap/web label media.
- Full-width reflective sensing for print format (length) using black marks, black lines, notches or holes.

For web/gap media, the printer senses the differences between the label and the liner to determine the print format length.

For continuous roll media, the printer only senses the media's characteristics. The print format's length is set by programming (driver or software) or the last stored form's length.

For black mark media, the printer senses the beginning of the mark and the distance to the start of the next black mark to measure the print format length.

For other common media and setting variations, see one of the following:

- [Using the Label Dispenser Option on page 76](#) after you have loaded media using this procedure.
- [Printing on Fan-Fold Media on page 73](#)

Instructions for media loading:

This procedure works for Tear-Off (standard bezel), Label Dispense and Media Cutting printer options.

1. Open the printer. Pull the release latch levers toward the front of the printer.

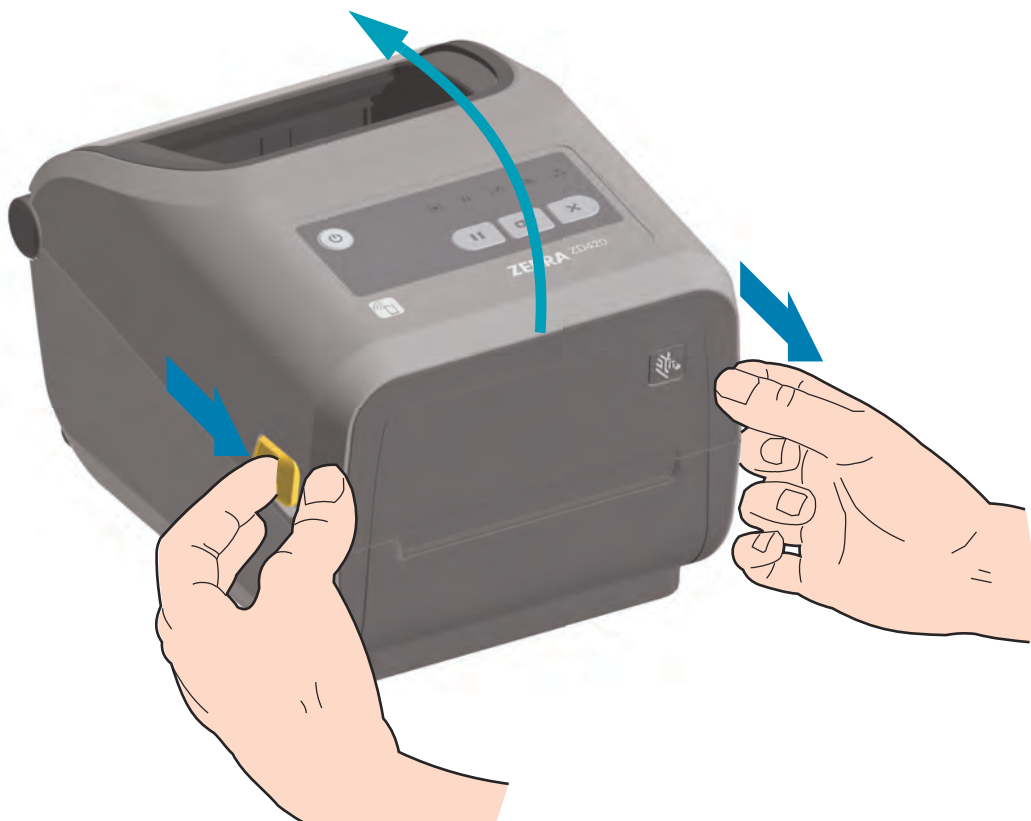

2. Open the media roll holders. Orient the media roll so that its printing surface will face up as it passes over the platen (drive) roller. Pull the media guides open with your free hand and place the media roll on the roll holders and release the guides. Verify the roll turns freely. The roll must not sit in the bottom of the media compartment.

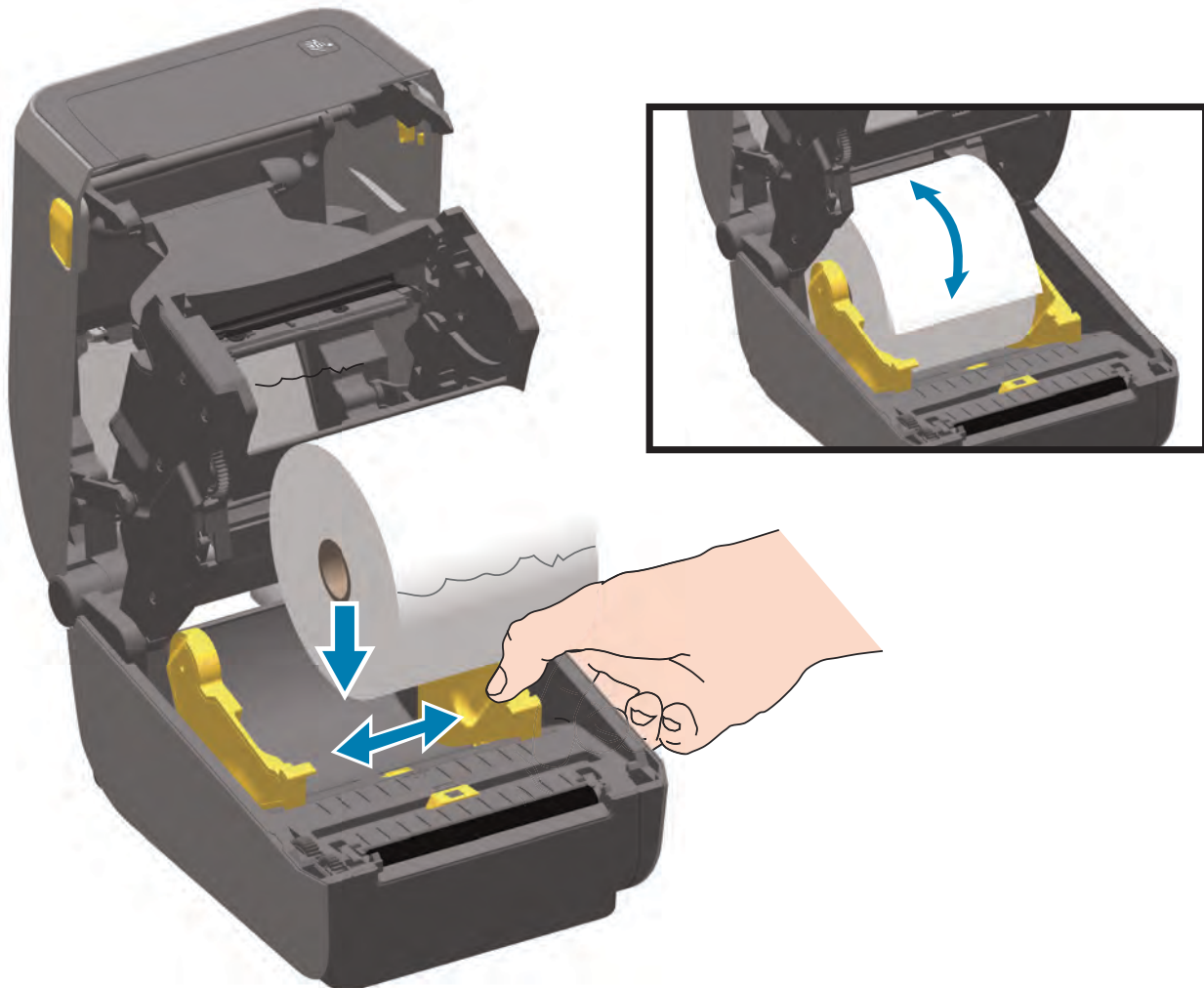

3. Pull the media so that it extends out of the front of the printer.

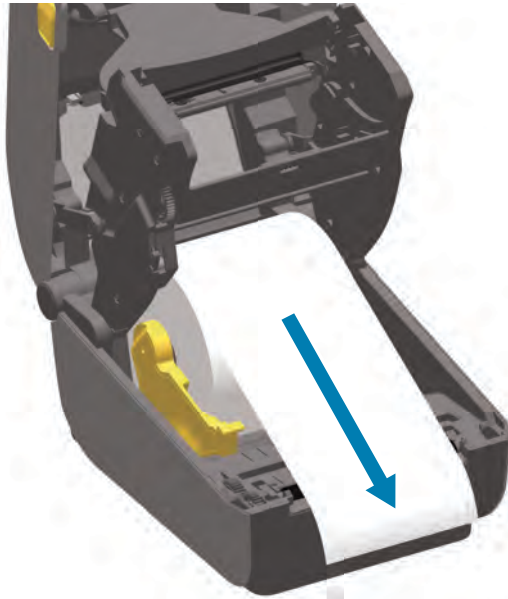

4. Push the media under both of the media guides.

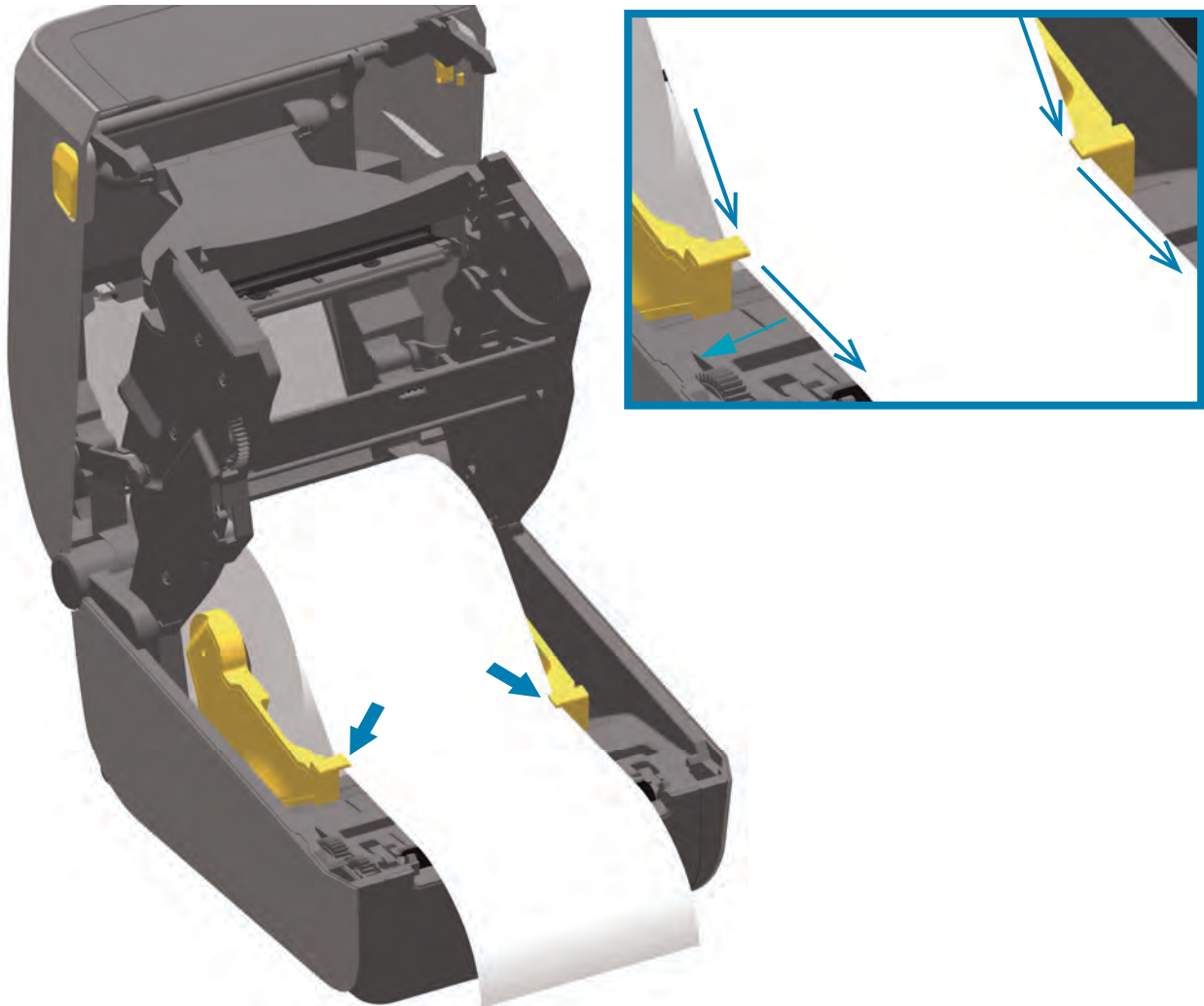

5. Flip the media up and align the movable media sensor for your media type.
 - **For continuous roll receipt type media or label media** without black marks or notches, align the media to the default center position.
 - **For black mark (black line, notches or holes) backed media**, adjust the sensor position so the sensor aligns to the center of the black mark. Avoid the center area of the media to only use black mark sensing for operation with black marks.

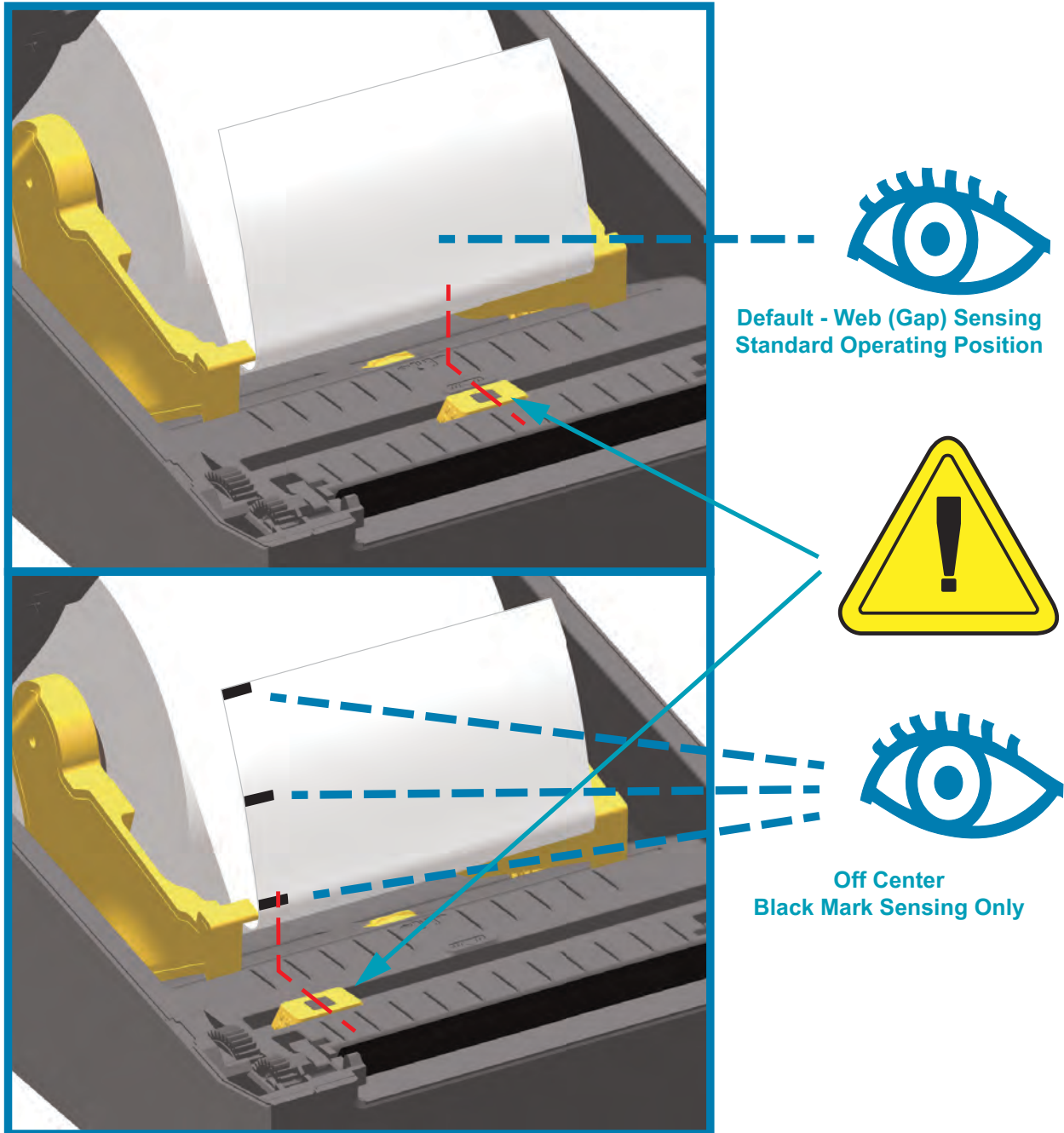

Using the Movable Sensor

The movable sensor is a dual function sensor. It provides transmissive (sees through media) and reflective media sensing. The printer can use either sensing method, but not both at the same time.

The movable sensor has a center array of sensors. This provides adjustable transmissive web (gap) sensing to positions that match legacy Zebra® desktop printer sensor locations and positions in between. This also provides for use of some non-standard media variations or irregularly shaped media.

The movable sensor allows the printer to use media with **black marks** or **notches** (holes through the media) on the back side of the media (or media liner). The sensor aligns to the middle of black marks or notches not in the center of the media roll to avoid Web/Gap sensing array.

Adjusting the Movable Sensor for Black Marks or Notches

The black mark sensing looks for non-reflective surfaces such as black marks, black lines, notches or holes on the back of the media which do not reflect the sensor's near infrared light beam back to the sensor's detector. The sensor light and its black mark detector are next to each other under the sensor cover.

Position the movable sensor's alignment arrow to the middle of the black mark or notch in the underside of the media. Sensor alignment should be set as far as possible from the edge of media but where 100% of the sensor window is covered by the mark. When printing, the media can move from side to side $\pm 1\text{mm}$ (due to media variations and edge damage due to handling). Notches cut into the side of the media can also become damaged.

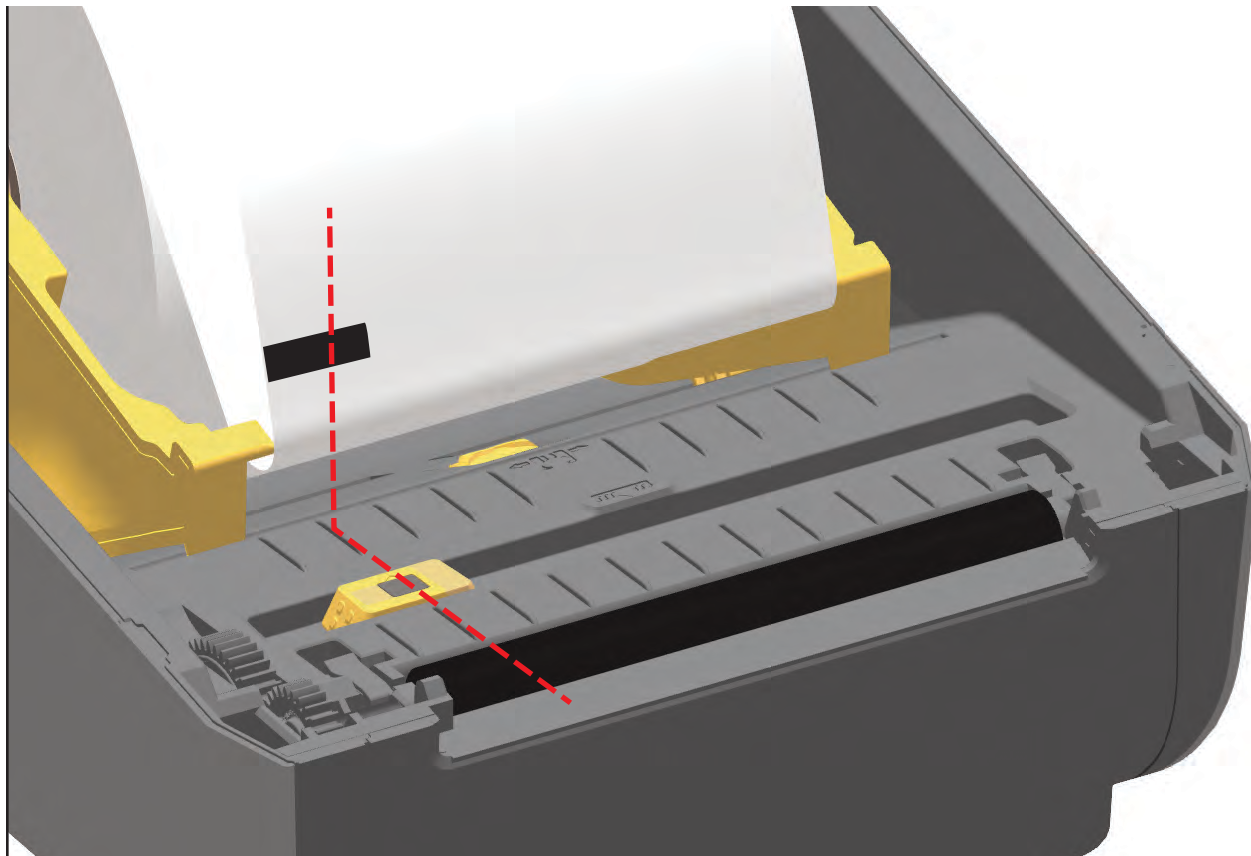

Adjusting the Movable Sensor for Web (Gap) Sensing

The movable sensor for web/gap sensing supports multiple positions.

- The movable sensor's 'Default' position is ideal for most label types.
- The adjustment range is from center to off-center positions which are ideal for printing two (2) labels side by side on a roll.
- The movable sensor adjustment range covers sensor positions use by legacy Zebra printers.

Web (Gap) sensing with the movable sensor only functions when the movable sensor's alignment arrow points to any position on the alignment key. The adjustment range is shown below.

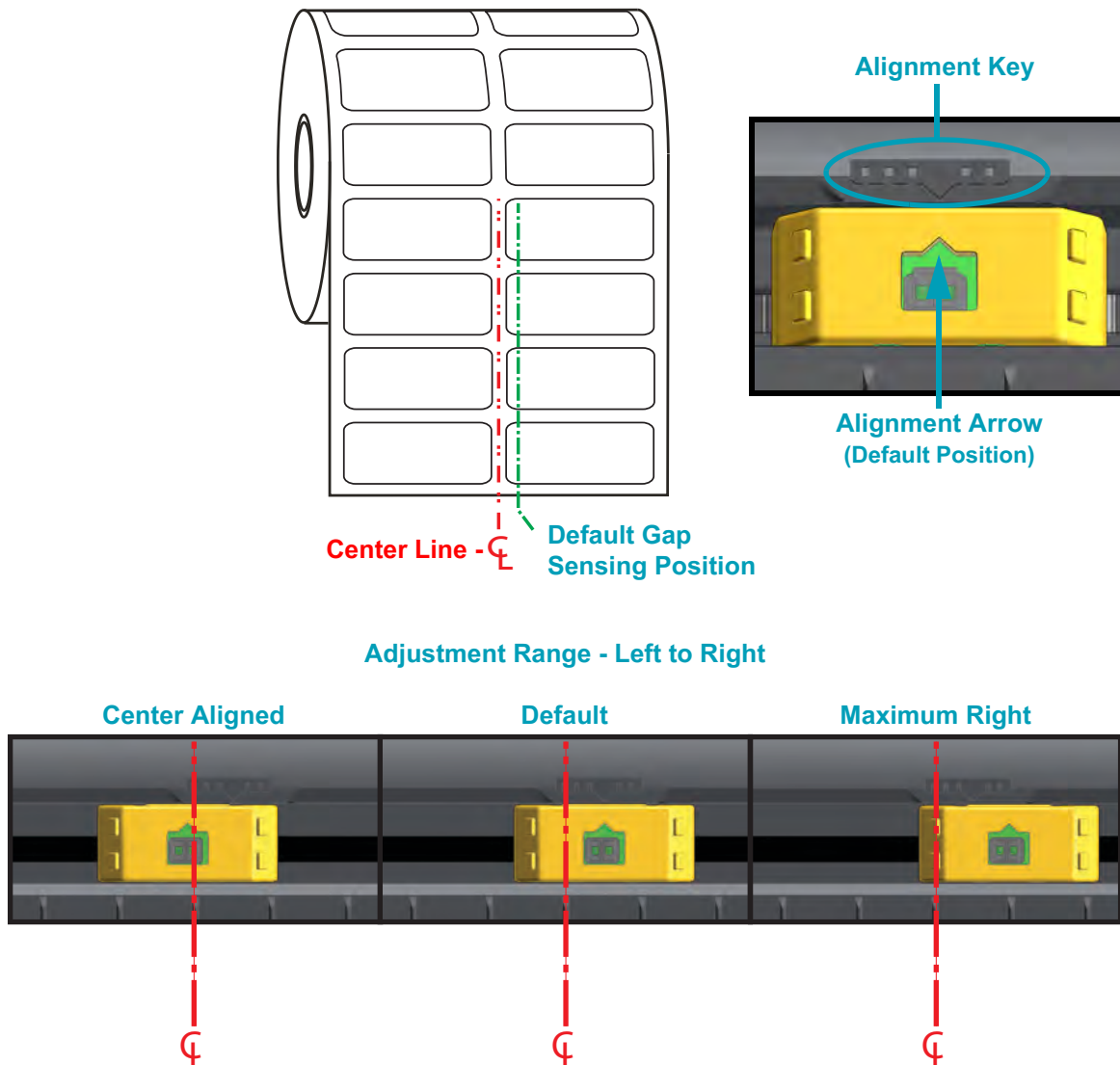

Zebra Printer Models Fixed Sensor Position Relative to the ZD420

- **Default** — Zebra Models: G-Series™ fixed position sensors, LP/TLP 2842™, LP/TLP 2844™, LP/TLP 2042™
- **Center Aligned** — Zebra Model: LP/TLP 2742™

Loading Roll Media (continued)

- Cutter Models** - For printers with the optional cutter module installed, thread the media through cutter's media slot and pull it out the front of the printer.

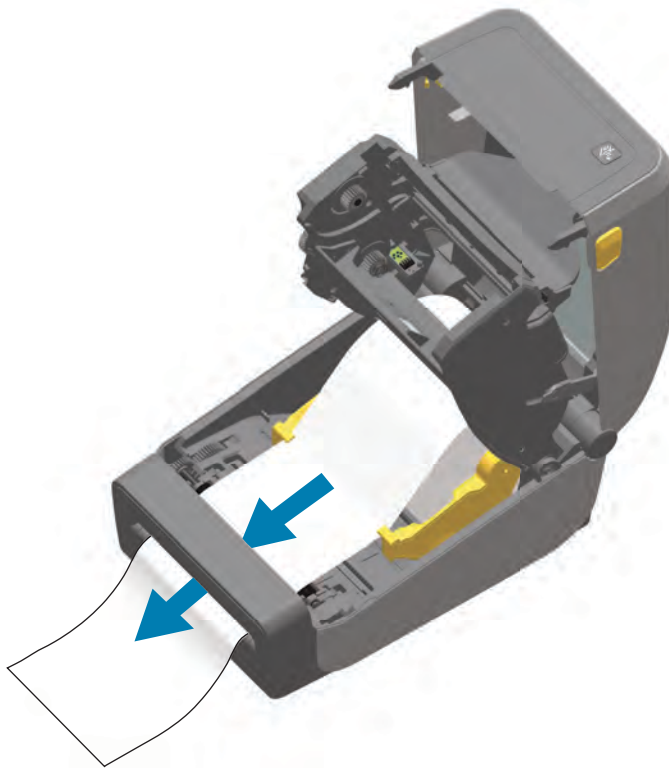

- Close the printer. Press down until the cover snaps closed.



You may need to calibrate your printer for the media. The printer's sensors need to adjust to sense the label, the liner, and the distance between labels to operate properly. When reloading the same media (size, vendor, and batch), you can just press the Feed (Advance) button once to prepare the media for printing.

Loading the Ribbon Cartridge

The printer uses a transfer ribbon cartridge for thermal transfer printing. Just slide the cartridge into the ribbon transport and close the printer. The printer reads cartridge information stored on the cartridge.

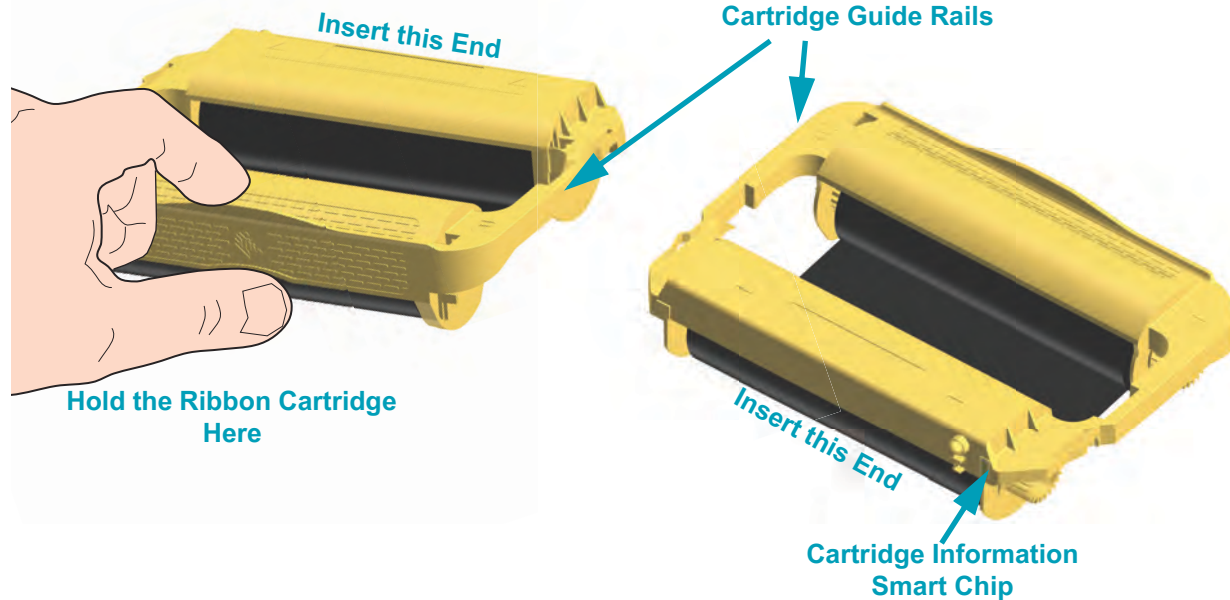

1. Insert the ribbon cartridge into the ribbon cartridge slot on the ribbon transport in your open printer. Push until the cartridge is nearly flush to the front of the ribbon transport. You will hear and feel the cartridge lock into place. Only Genuine Zebra Ribbon Cartridges are supported.

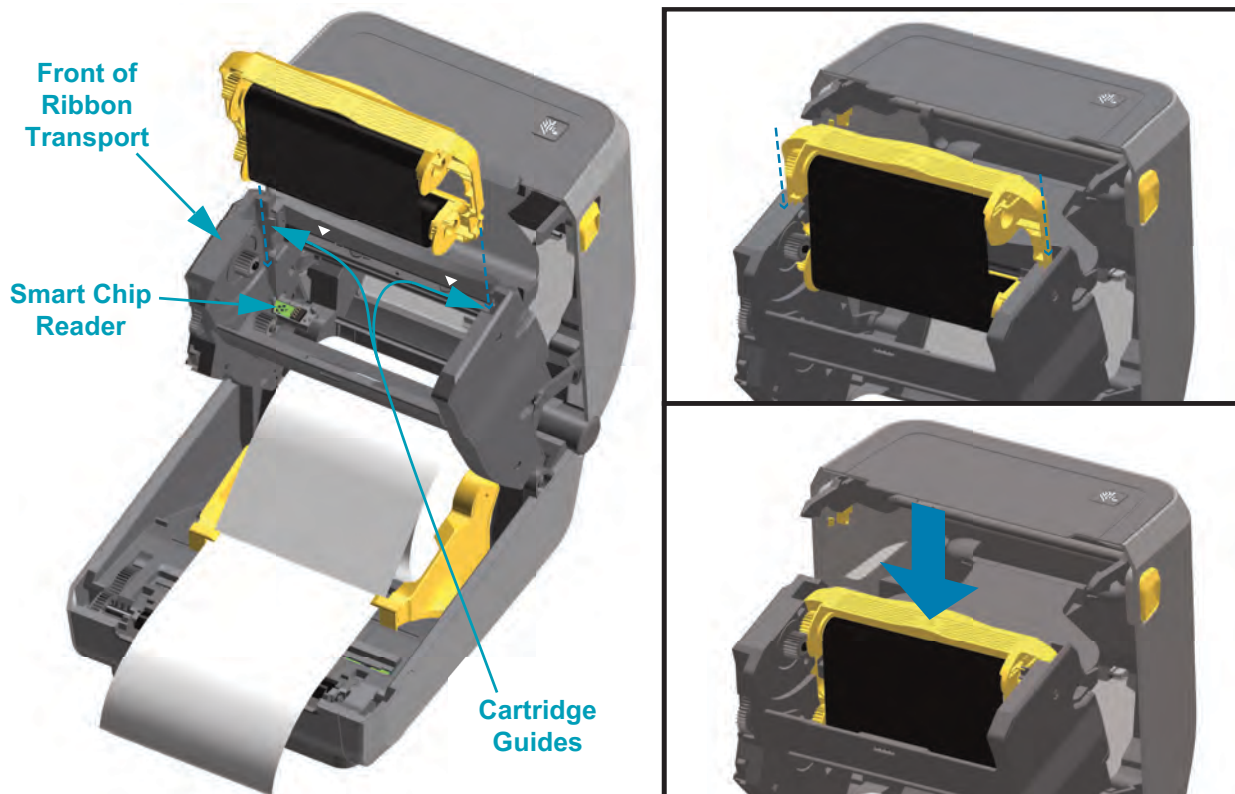

Run a SmartCal Media Calibration

The printer needs to set the media parameters for prior to printing optimal operation. The printer will automatically determine media type (web/gap, black mark/notch, or continuous) and measure media characteristics.



Note • After the initial calibration to a specific media is completed, it is not required to perform additional calibrations each time the media is replaced. The printer automatically measures the media to adjust for small changes in the media characteristics while printing.

Pressing the Feed (Advance) once or twice after a new roll of media (same batch) has been installed will synchronize the labels. It is then ready to continue printing.

SmartCal Procedure

1. Make sure the media and ribbon cartridge (if you are thermal transfer printing) are loaded properly in the printer and the top cover of the printer is closed.
2. Press the POWER button to turn the printer on.
3. Once the printer is in the ready state (Status indicator (◊) is solid green), press and hold the PAUSE and CANCEL button for two (2) seconds and release.
4. The printer will measure a few labels and adjust media sensing levels.
5. When the printer stops, the Status indicator (◊) will turn solid green.

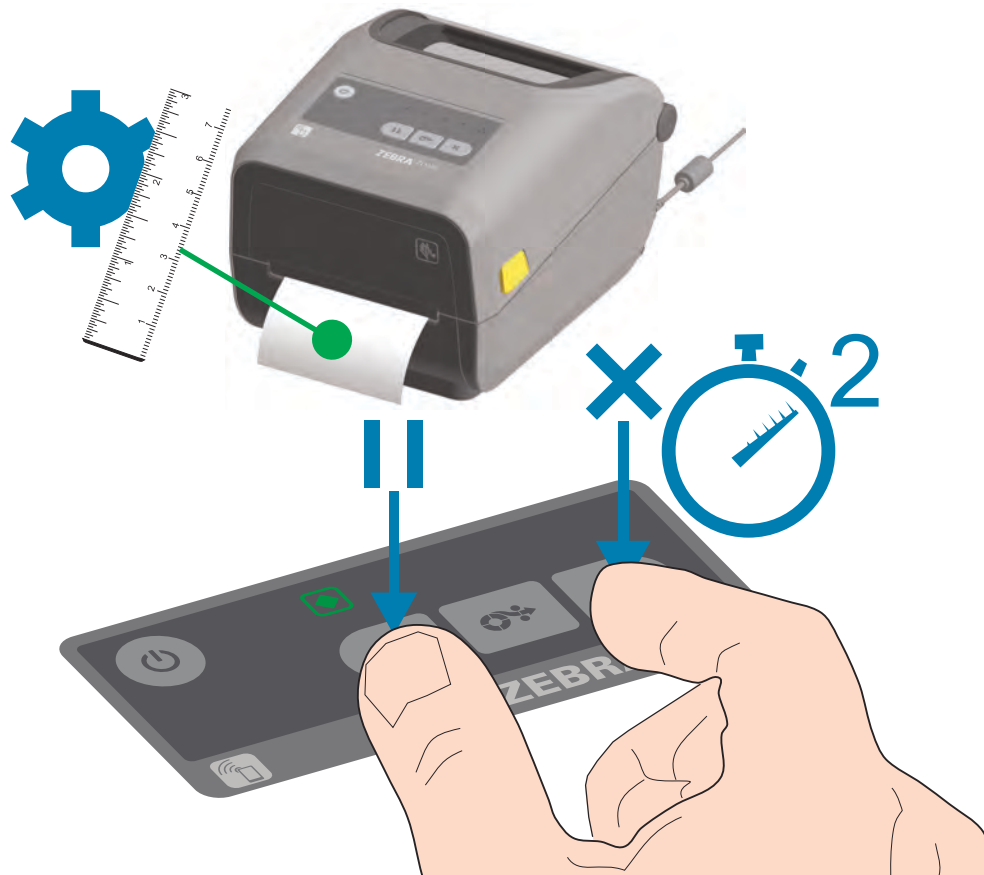

Test Printing with the Configuration Report

Before you connect the printer to a computer, make sure that the printer is in proper working order. You can do this by printing a configuration report. The information on the Configuration reports printout that may be helpful with printer installation and with troubleshooting your printer.

1. Make sure the media and ribbon cartridge (if you are thermal transfer printing) are loaded properly in the printer and the top cover of the printer is closed.
2. Turn the printer ON.
3. Once the printer is in the ready state (Status indicator (◊) is solid green), press and hold the **FEED and CANCEL** buttons for two (2) seconds and release.
4. The Printer and Network Configuration Reports (shown below) will be printed.
5. When the printer stops, the Status indicator (◊) will turn solid green.

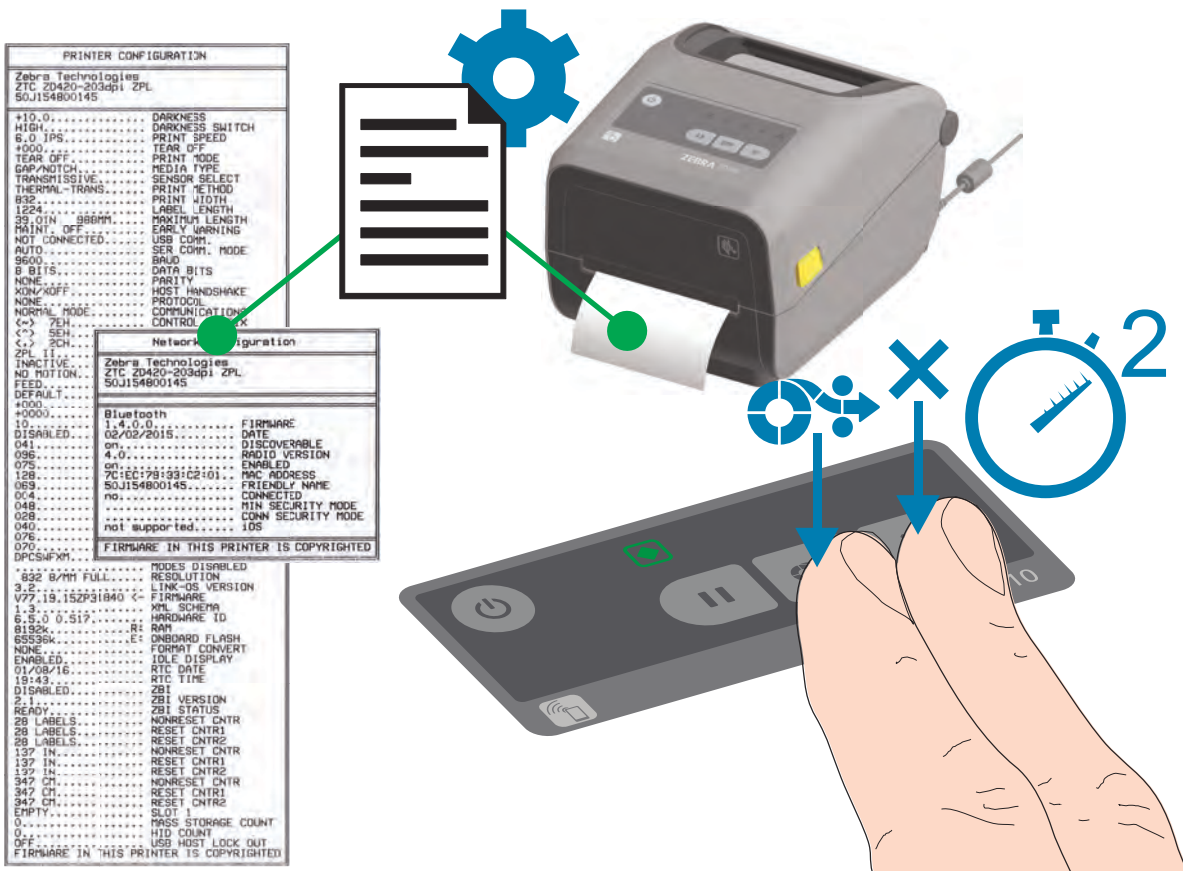

If you cannot get these firmware reports to print, then see [Troubleshooting on page 83](#).

Detecting a Media Out Condition

When you run out of media, your printer will report a 'Media Out' condition with the Status and Media indicators. This is part of the normal media usage cycle.

When the printer detects that the media is out, the Status (◻) and Media (🌀) indicators will turn solid red.

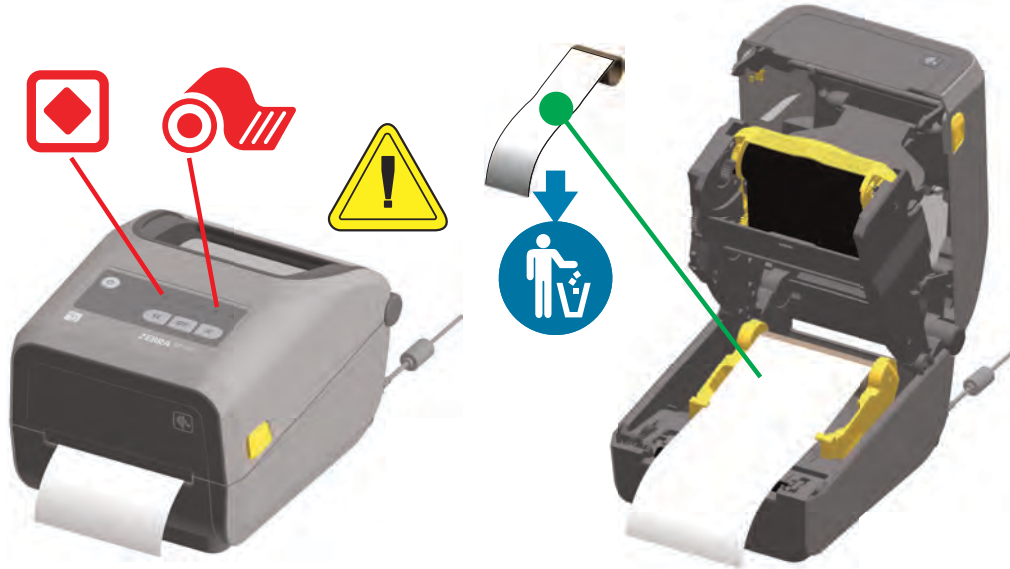

Recovering from a Media Out condition

1. Open the printer.
2. Observe that the media is at the end or nearly at the end of the roll with a label missing from the liner.
3. Remove the remaining media and roll core.
4. Insert a new roll of media. See [Loading Roll Media on page 32](#).
5. If you are installing more of the same media, just load the new media and press the Feed (Advance) button once to resume printing.

If you are loading different media (size, vendor, or even batch is different), then reloading media followed by a SmartCal is needed to ensure optimal operation.

Note that changing media size (length or width) usually requires to you to change the programmed media dimensions or the active label format in the printer.



Note • Sometimes a label may be missing some where in the middle of your roll of labels (not at the end of media). This will also cause a 'Media Out' condition.

To recover, just pull the media out until the next label is over the platen roller. Close the printer. Press the Feed (Advance) button once. The printer will resynchronize the label position and will be ready to resume printing.

Detecting a Ribbon Out Condition

When you run out of printable ribbon, your printer will report a 'Ribbon Out' condition with the Status and Media indicators. This is part of the normal media usage cycle.

When the printer detects that the media is out, the Status (◊) indicator will turn solid red and the Media (🖨️) indicator will be flashing red.

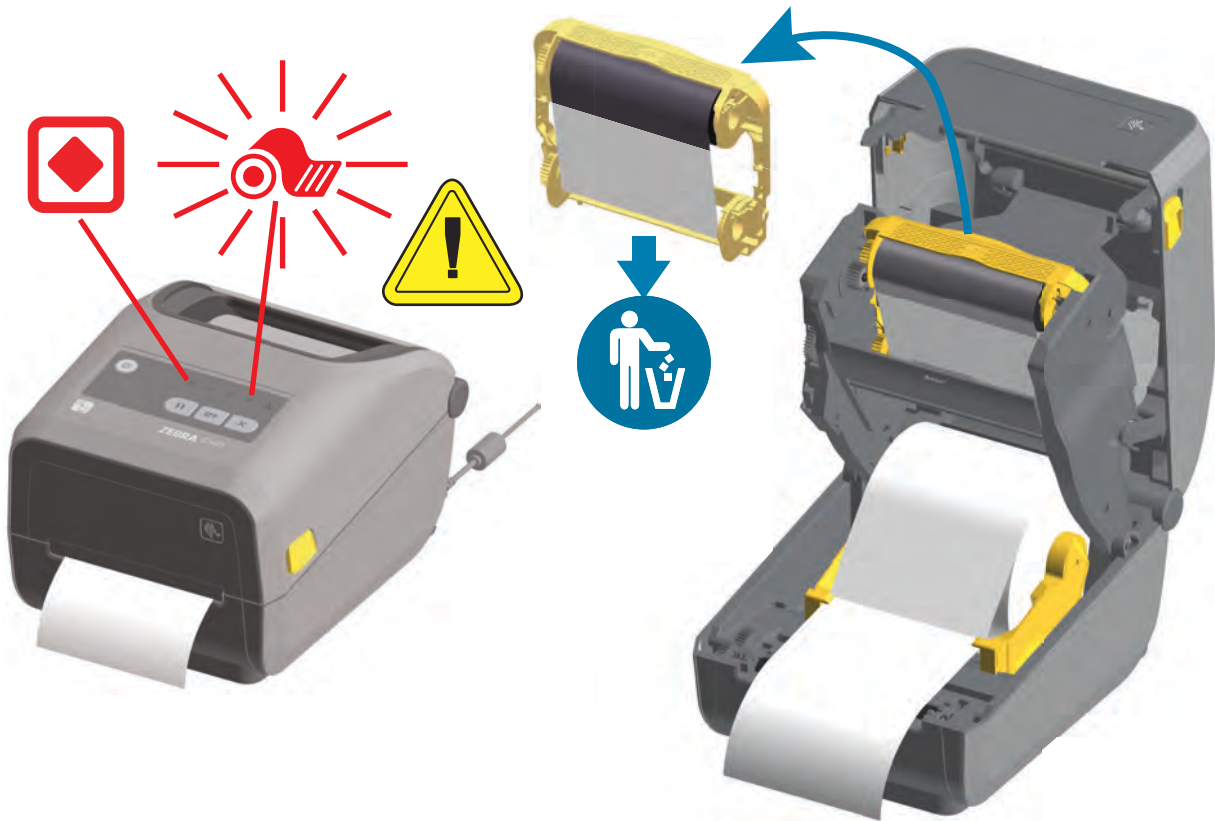

Recovering from a Ribbon Out condition

1. Open the printer.
2. Observe a reflective ribbon (used to detect end of ribbon) is exposed on the underside of the ribbon cartridge. The front ribbon roll is also full.
3. Remove the used ribbon cartridge and dispose of it properly.
4. Insert a new ribbon cartridge. See [Loading the Ribbon Cartridge on page 39](#).
5. Press the Feed (Advance) button once to resume printing.



Note • Institutions operating under HIPAA directives must destroy the used ribbon on the cartridge.

Connecting your Printer to a Computer

The printer supports a variety of interface options and configurations. These include:

- Universal Serial Bus (USB 2.0) interface - Standard
- RS232 Serial - Field Upgrade Option
- Ethernet (LAN) - Field Upgrade Option
- Internal WiFi (802.11ac) and Bluetooth Classic 4.1 (3.0 Compatible) - Factory Installed Option
- Bluetooth Low Energy (low speed connection) for printer configuration using software running on an Android or iOS device.

Pre-install Windows® Printer Drivers

Install the Zebra Setup Utilities (ZSU) before applying power to the printer connected to the PC. The utility installs the Zebra Windows drivers first. The ZSU installation wizard will then prompt you turn on the printer. Follow the instructions to complete your printer installation.

The Zebra Setup Utility is designed to assist you with installing your printer. The cabling and unique parameters for each of these physical printer communication interfaces is discussed in the following pages to assist you with making configuration setup choices prior to and immediately following applying power. The Zebra Setup Utilities configuration wizards will instruct you to turn the printer's power on at the appropriate time to complete the installation of your printer.

For more details on configuring network (Ethernet or Wi-Fi) and Bluetooth communication, see the following guides:

- Wired and Wireless Print Server User Guide
- Bluetooth Wireless Guide

Interface Cable Requirements

Data cables must be of fully shielded construction and fitted with metal or metalized connector shells. Shielded cables and connectors are required to prevent radiation and reception of electrical noise.

To minimize electrical noise pickup in the cable:

- Keep data cables as short as possible (1.83 m [6 foot] recommended).
- Do not tightly bundle the data cables with power cords.
- Do not tie the data cables to power wire conduits.



Important • This printer complies with FCC “Rules and Regulations,” Part 15, for Class B Equipment, using fully shielded data cables. Use of un-shielded cables may increase radiated emissions above the Class B limits.

USB Interface

Universal Serial Bus (version 2.0 compliant) provides a fast interface that is compatible with your existing PC hardware. USB's "plug and play" design makes installation easy. Multiple printers can share a single USB port/hub.

When using a USB cable (not supplied with your printer), verify that the cable or cable packaging bears the "Certified USB™" mark (see below) to guarantee USB 2.0 compliance.

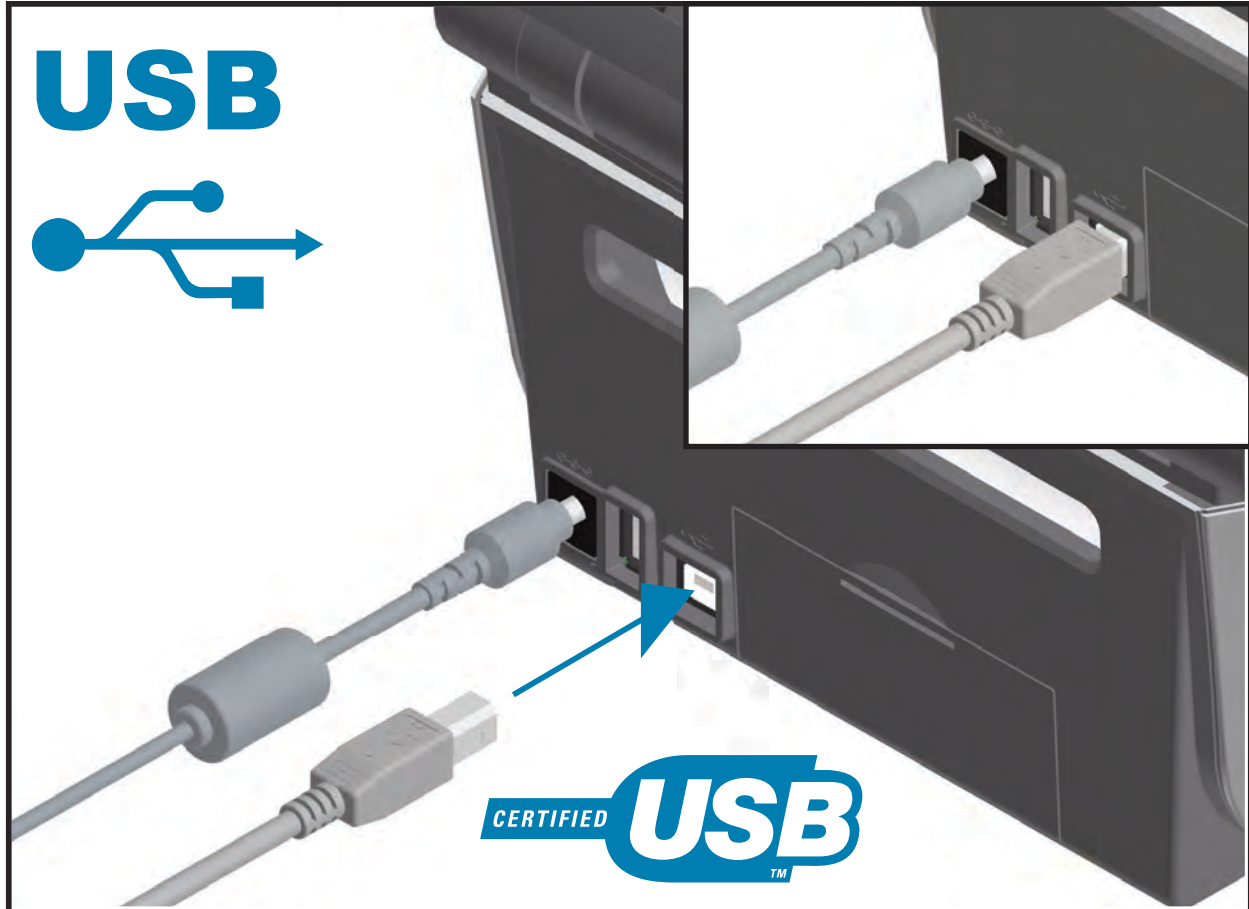

Serial Interface

The printer uses a Null Modem (cross-over) cable for DTE communications. The required cable must have a nine-pin “D” type (DB-9P) male connector on one end which plugs into the mating (DB-9S) serial port located on the back of the printer. The other end of this signal interface cable connects to a serial port on the host computer. For pin-out information, refer to Appendix A.

The serial port communication settings between the printer and host (typically a PC) must match for reliable communication. The Bits per second (or Baud rate) and Flow control are the most common settings that get changed.

Serial communications between the printer and the host computer can be set by:

- ZPL programming ^SC command
- Resetting the printer to its default printer configuration.

Factory defaults for serial communication settings are: 9600 baud, 8 bit word length, NO parity, 1 stop bit, and XON/XOFF (‘Software’ data flow control in the Windows based host system).

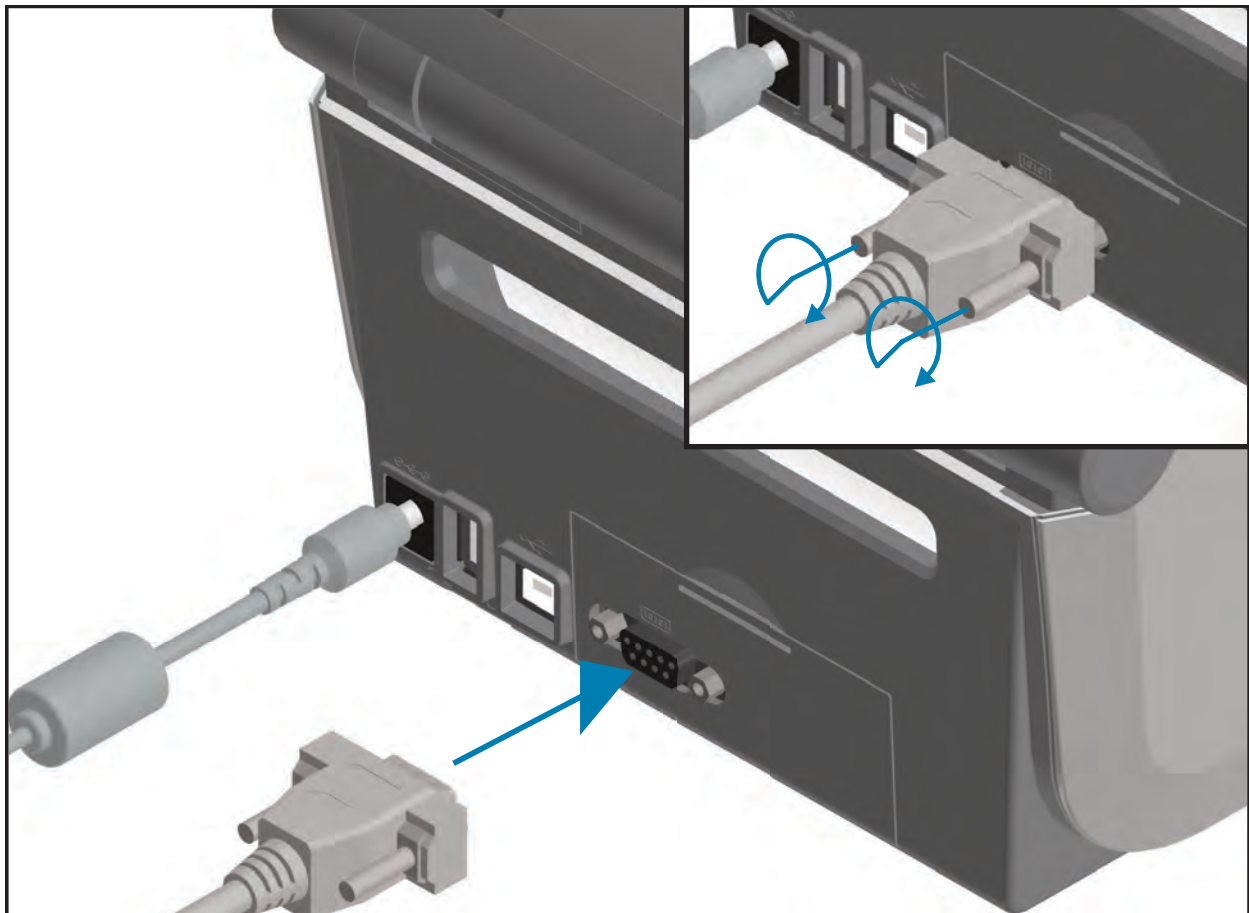

Note • Do not use RS-232 cable adapter dongles (DTE ↔ DCE) with this printer. Some dongles can interfere with the operation of USB Host port devices at printer power up.

Ethernet (LAN, RJ-45)

The printer requires UTP RJ45 Ethernet cable rated CAT-5 or better.

The printer has a built-in network print server. For more information on configuring your printer to run on a compatible Ethernet based network, see the Wired and Wireless Print Server users guide. The printer must be configured to run on your network. The print server on board your printer can be accessed through the printer's print server Web pages.

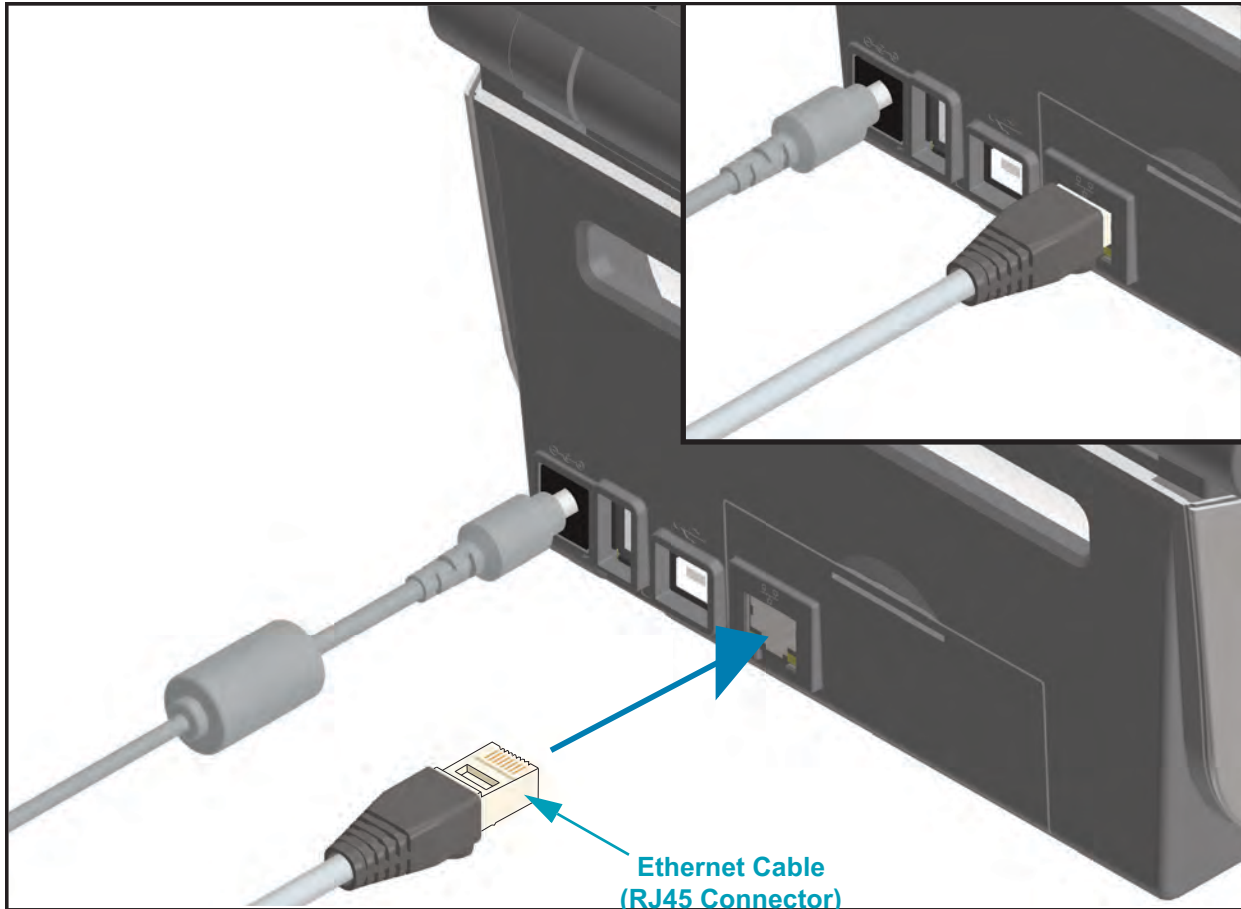

Ethernet Status/Activity Indicators

The Ethernet connector on the printer has two (2) status/activity indicators that are partially visible to provide interface status at the connector. The printer also has the control panel indicator lights for printer network operation status, see the [Meaning of the Indicator Light Patterns on page 84](#) for more details.

LED Status	Description
Both OFF	No Ethernet link detected
Green	100 Mbps link detected
Green with the Amber flashing	100 Mbps link and Ethernet activity detected
Amber	10 Mbps link detected
Amber with the Green flashing	10 Mbps link and Ethernet activity detected

Assigning an IP Address for Network Access

All devices on an Ethernet network (LAN and WLAN) require a network IP (Internet Protocol) address. The printer's IP address is needed to access the printer for printing and printer configuration. The five different ways to assign an IP address are:

- DHCP (Dynamic Host Connection Protocol) - Default setting
- Zebra Setup Utilities (includes the ZebraDesigner Windows printer driver)
- Telnet
- Mobile Apps
- ZebraNet Bridge

DHCP for Personal Networks

The printer by default is set to operate on a Ethernet LAN or Wi-Fi network with DHCP. This setting is intended primarily for personal networks. The network automatically provides a new network IP address each time the printer is turned on. The Windows printer driver uses a Static IP address to connect to the printer. The IP address set in the printer driver will need to be changed to access the printer if its assigned IP address has changed after the printer's initial installation.

Managed Networks

Using the printer in a structured network (LAN or Wi-Fi) requires a network administrator to assign the printer a Static IP address and other settings needed to operate on the network properly.

Print Server - Default User ID and Password

There are some features that require the default User ID and/or default password to access the printer's print server or if you have the Wi-Fi option in the printer. The Factory Default Values are shown below:

- **User ID:** admin
- **Password:** 1234

Wi-Fi and Bluetooth Classic Wireless Connectivity Option

This guide covers basic configuration of your Internal Wi-Fi Print Server and Bluetooth Classic 4.X wireless connectivity option. This manual only covers installing the Wi-Fi as part of the Wi-Fi and Bluetooth Classic wireless connectivity option in the [Setting Up the Wi-Fi Print Server Option on page 51](#). See the Zebra Web site for **Wired and Wireless Print Server User Guide** for more information on the printer's Ethernet operation.

This manual only covers installing the Bluetooth as part of the Wi-Fi and Bluetooth Classic wireless connectivity option in the [Bluetooth Option Configuration on page 60](#). See the Zebra Web site for **Bluetooth Wireless Guide** for more information on the printer's Bluetooth operation.

Update Printer Firmware to Finish Option Installations

It is recommended that you always update the printer's firmware with the latest version for optimal printer performance. For instructions on how to update printer firmware, see [Updating Printer Firmware on page 92](#). This is located on the Zebra Web site at:

<http://www.zebra.com/support>

Setup for Windows OS

This section assists you in setting up and operating your printer for the first time.

Windows Operating Systems Printer Setup (Overview)

For supported Windows Operating systems (most common) with a Local (cabled) connection:

- 'Run' the Zebra Setup Utilities from the User's CD or from the Zebra Web site.
- Click on 'Install New Printer' and run the install wizard. Select 'Install Printer' and select the ZD420c from the list of ZDesigner printers.
- Select the port (USB or Serial) that you connected to the PC. One of these interfaces are also used by the Zebra Setup Utility's Wizard to assist installation of networked and Bluetooth Classic (4.0).
- Turn the printer ON and configure printer communications for your interface type.
- Use the Windows driver to print a 'Test Print' to verify operation with Windows.

Pre-install Windows[®] Printer Drivers

Install the Zebra Setup Utilities (ZSU) before applying power to the printer connected to the PC (running a Zebra driver supported Windows operating system). The utility installs the Zebra Windows drivers first. The ZSU installation wizard will then prompt you to apply the printer power. Continue to follow the instructions to complete your printer installation.

The Zebra Setup Utility is designed to assist you with installing these interfaces. The cabling and unique parameters for each of these physical printer communication interfaces is discussed in the following pages to assist you with making configuration setup choices prior to and immediately following applying power. The Zebra Setup Utilities configuration wizards will instruct you to turn the printer's power on at the appropriate time to complete the installation of your printer.

For more details on installing Ethernet (network) and Bluetooth interfaces:

- Wired and Wireless Print Servers User Guide
- Bluetooth Wireless Guide

Setting Up the Wi-Fi Print Server Option

This section covers basic configuration of your internal Wi-Fi Print Server option. For more detailed information, refer to the **Wired and Wireless Print Servers User Guide**.



Important • The wireless radio option, which includes Wi-Fi, Bluetooth classic and Bluetooth low energy, is only available as a factory installed configuration.

You may configure your printer for wireless operation in the following ways. This basic guide covers only the first option, the **Connectivity Wizard**.

- **Through the Connectivity Wizard**, which writes a ZPL script for you. On the last screen of the utility, you may choose to send the command directly to your printer, or you may choose to save the ZPL script to a file. The saved ZPL file has several purposes:
 - The file can be sent to the printer through any available connection (serial, parallel, USB, or wired print server).
 - The file can be resent to the printer after the network settings have been restored to factory defaults.
 - The file can be sent to multiple printers that will use the same network settings.
- **Through ZPL script** that you write yourself. Use the `^wX` command to set the basic parameters for security type. You can send the command through any available connection (serial, parallel, USB, or wired print server). Refer to the **ZPL Programming Guide** for more information on this option.
- **Through Set/Get/Do (SGD) commands** that you send to the printer. Begin with `wlan.security` to set the wireless security type. Depending on which security type that you select, other SGD commands will be necessary to specify other parameters. You can send the commands through any available connection (serial, parallel, USB, or wired print server). Refer to the ZPL Programming Guide for more information on this option.

Configure Using the Connectivity Wizard

The ZebraNet Bridge Enterprise utility is available through <http://www.zebra.com/software>. ZebraNet Bridge Enterprise version 1.2.5 or later is required to configure the printer correctly for use.

The Connectivity Wizard, which is part of this software, allows you to configure your printer easily for wireless operation by writing the appropriate ZPL script for you. Use this utility when you are first installing the wireless print server or after you set the network options back to factory defaults.



Note • You can only set up one print server at a time with the Connectivity Wizard. To configure multiple print servers (wired and wireless), run the program once for each print server.

To use the Connectivity Wizard, complete these steps:

1. If it is not already installed, install ZebraNet Bridge Enterprise on your computer.
You can get the program from the user CD that came with your printer, or you can download it at <http://www.zebra.com/software>.
2. Launch the ZebraNet Bridge Enterprise program.
If you are prompted for a serial number, you may click Cancel. You will still be able to use the Connectivity Wizard.
3. From the Menu bar, select Tools > Connectivity Wizard.
The Connectivity Wizard opens.

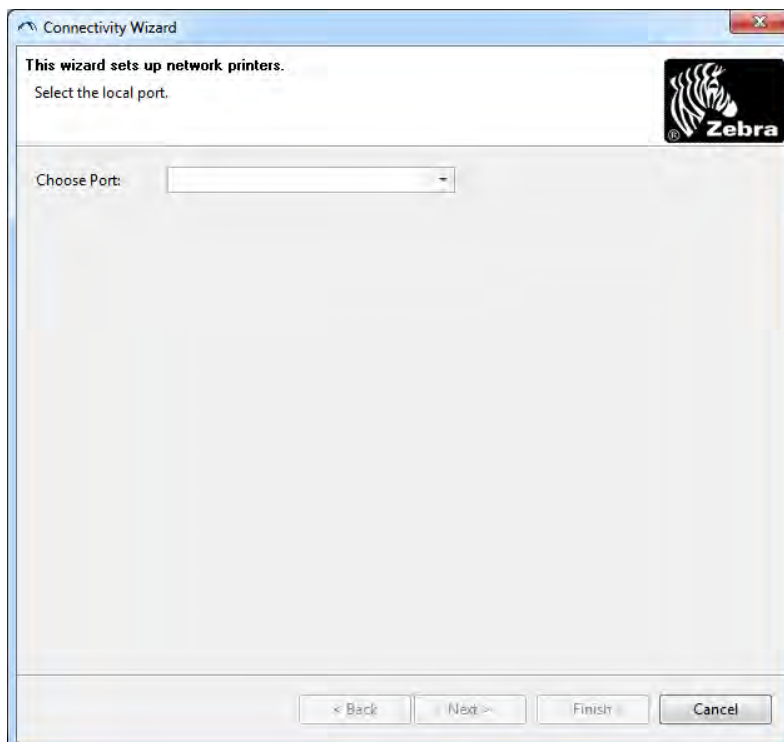

4. From the Choose Port list, select the port to which your printer is connected.
 - If you will save the file without sending it to the printer, you may select any available port.
 - If you select File:, you will be asked to browse to the location of the file you want to save.
 - If you select a serial port, the serial configuration information appears below the 'Choose Port' list. If necessary, change the serial communication settings to match your printer's settings.



Note • If a port is in use by another device, it will not be included in the drop-down list.

5. Click Next.

The wizard prompts for the print server device to configure.

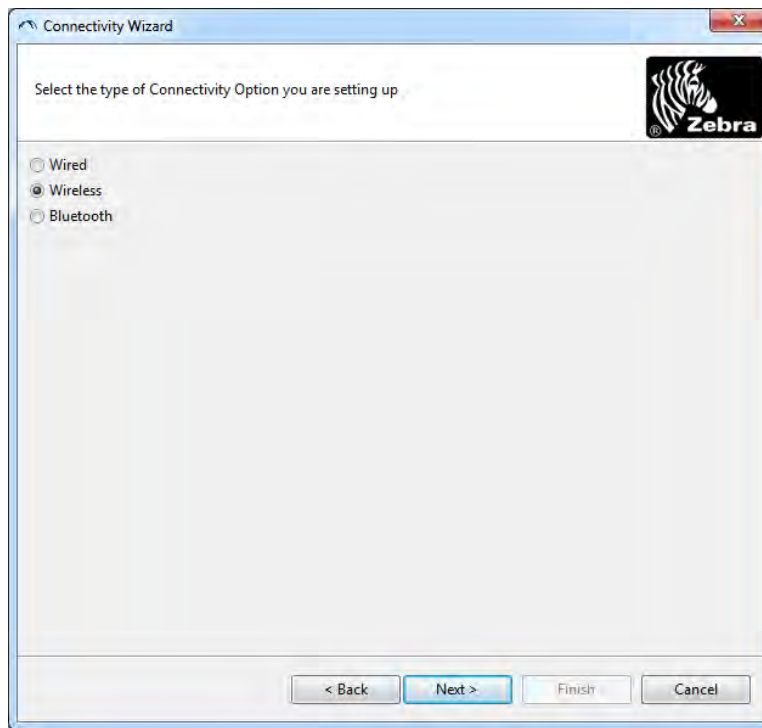

- 6. Select Wireless and then click Next.
The wizard prompts you for the type of printer you are using.

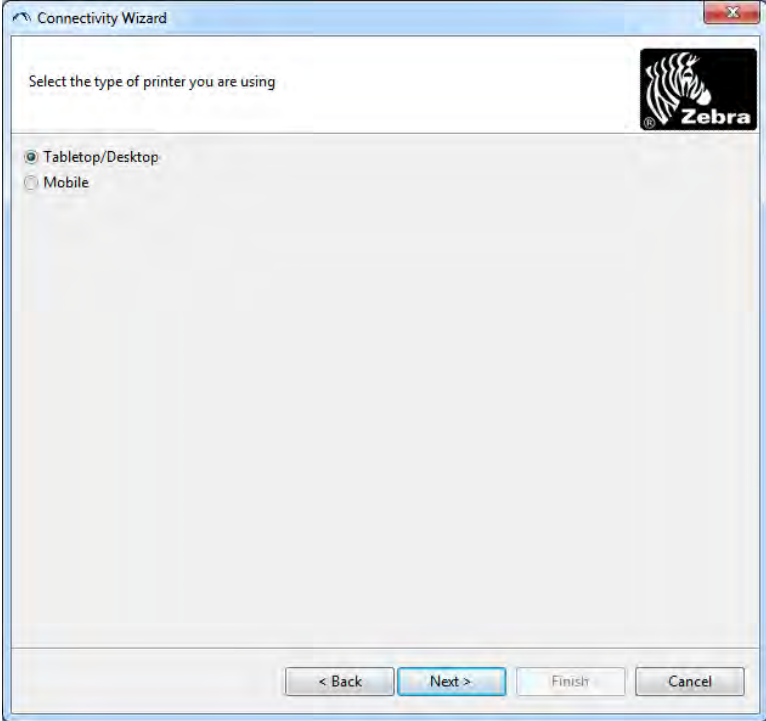

- 7. Select the type of printer you are using and then click Next.
The wizard prompts for the wireless IP information.

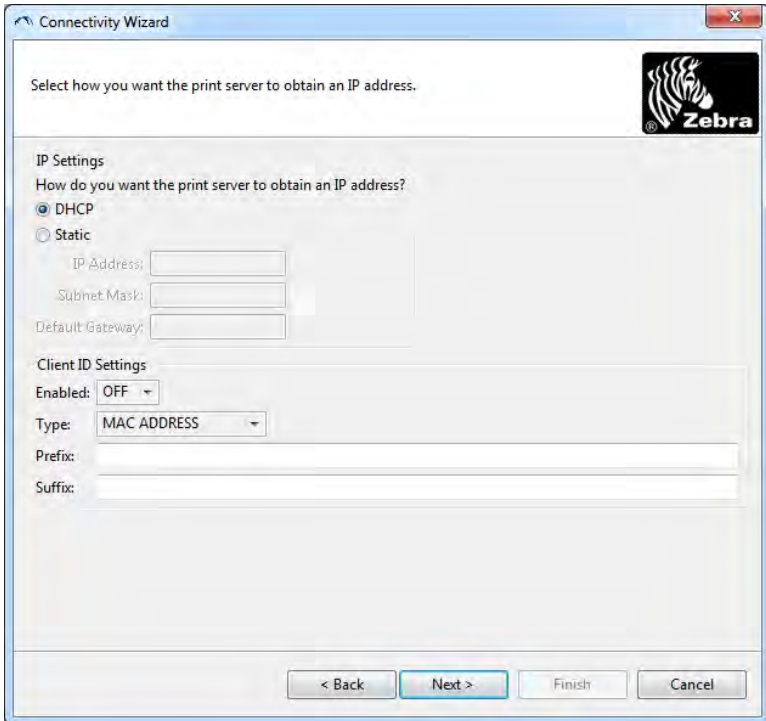

8. Enable the DHCP (dynamic) or static IP option.

If you will be using...	Complete the following steps...
DHCP	<ol style="list-style-type: none"> Select DHCP and click Next. Continue with step 9.
Static	<ol style="list-style-type: none"> Select Static. The IP settings fields are activated. Enter the IP Address, Default Gateway, and Subnet Mask for the wireless print server. Contact your network administrator for the correct values. Continue with step 9.

9. Click Next.

The Wireless Settings window opens.

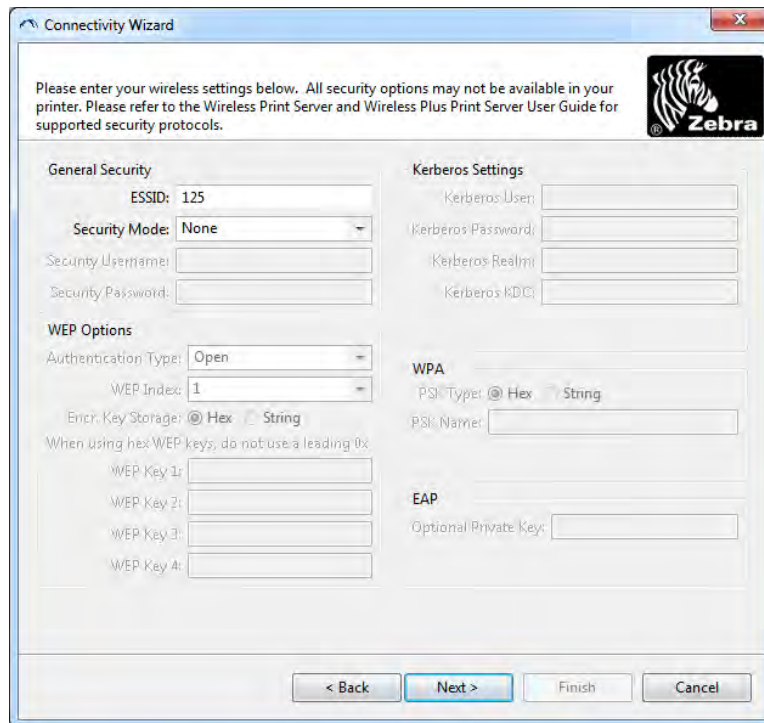

10. Enter the ESSID.



Important • The ESSID and pass phrase, if used, must be set at your access point before completing these steps.

11. From the drop-down, select your Security Mode.

If you select...	Then...
None	Continue with step 12 .
WEP 40-Bit WEP 128-Bit	<p>a. In the WEP Options section of the window, enter the following values:</p> <ul style="list-style-type: none"> • Authentication type • WEP Index • Encryption Key Storage • WEP Keys <p>b. Click Next and continue with step 12.</p>
EAP-TLS EAP-TTLS EAP-FAST WPA-EAP-TLS	<p>In the EAP section of the window, if necessary:</p> <p>a. Enter the Optional Private Key.</p> <p>b. Click Next and continue with step 12.</p>
PEAP LEAP WPA-EAP-TTLS WPA-PEAP WPA-LEAP	<p>In the General Security section of the window:</p> <p>a. Enter the Security Username and Password.</p> <p>b. Click Next and continue with step 12.</p>
WPA-PSK	<p>In the WPA section of the window:</p> <p>a. Select the PSK Type.</p> <p>b. Enter the PSK Name.</p> <p>c. Click Next and continue with step 12.</p>
WPA-EAP-FAST	<p>a. In the General Security section of the window, enter the Security Username and Password.</p> <p>b. In the EAP section of the window, if necessary, enter the Optional Private Key.</p> <p>c. Click Next and continue with step 12.</p>
KERBEROS	<p>a. In the Kerberos Settings section of the window, enter the following values:</p> <ul style="list-style-type: none"> • Kerberos User • Kerberos Password • Kerberos Realm • Kerberos KDC <p>b. Click Next and continue with step 12.</p> <p> c. KERBEROS is not supported on Internal Wireless Plus print servers or radio cards.</p>

- Click Advanced Options in the Wireless Settings window.
 The Advanced Wireless Settings window opens.

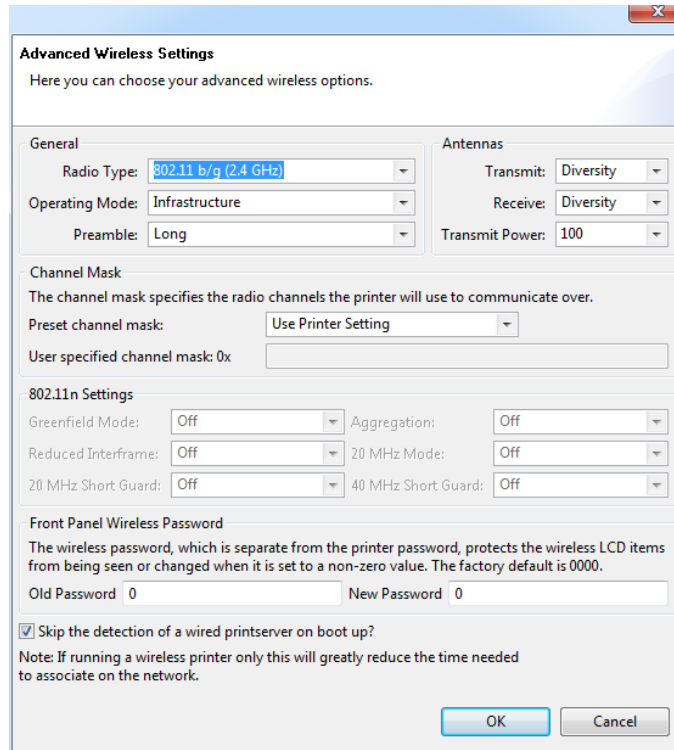



- Review the settings in the Advanced Wireless Settings window. Change the settings as necessary, and then click OK.
 The Wireless Settings window returns.

14. Click Next.

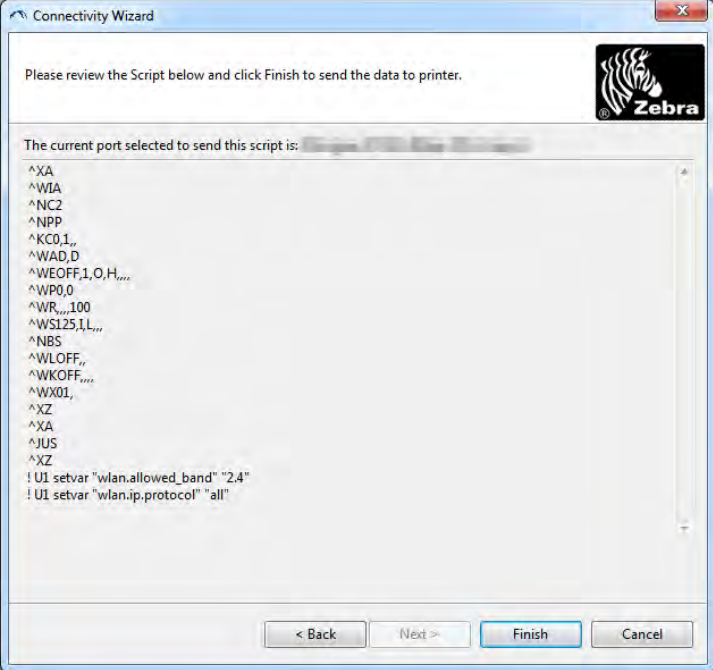
Based on your selections in the Wireless Setup Wizard, the program writes the appropriate ZPL commands and displays them for your review.

If you selected...	Then a dialog box similar to this displays.
Tabletop/Desktop	 <p>The screenshot shows a window titled "Connectivity Wizard" with a Zebra logo in the top right corner. The text inside the window reads: "Please review the Script below and click Finish to send the data to printer." Below this, it says "The current port selected to send this script is: [Port Name]". A scrollable list of ZPL commands is displayed, including: ^XA, ^WIA, ^NC2, ^NPP, ^KCO,1,, ^WAD,D, ^WEOF,1,O,H,,, ^WP0,0, ^WR,,,100, ^WS125,1,L,,, ^NBS, ^WLOFF,, ^WKOFF,,, ^WX01,, ^XZ, ^XA, ^JUS, ^XZ, ! U1 setvar "wlan.allowed_band" "2.4", and ! U1 setvar "wlan.ip.protocol" "all". At the bottom of the window are four buttons: "< Back", "Next >", "Finish", and "Cancel".</p>

15. Determine if you will send the script immediately, or save it for use at a later time.

To...	Then...
Complete setup by sending the ZPL script to the printer through the port selected at the beginning of this procedure	<p>a. Verify that the printer is connected to the computer through the port you selected.</p> <p> Note • For serial connections, use a serial null modem cable.</p> <p>b. If you have not already done so, turn ON the printer.</p> <p>c. On the Review and Send ZPL for Wireless window, click Finish.</p> <p>The printer sends the ZPL script to the printer through the selected port. The Wireless Setup Wizard screen closes.</p> <p>d. Turn the printer OFF and then back ON.</p>
Save the ZPL script to a file for use later or for use with other printers	<p> Note • You can send the ZPL script file to multiple printers that use the same configuration, or you can send the file to a printer that had the network settings restored to the factory defaults. This saves you from having to go through the Wireless Setup Wizard more than once.</p> <p>a. On the 'Review and Send ZPL for Wireless' window, highlight the script, right-click, and select Copy.</p> <p>b. Open a text editor, such as Notepad, and paste the script into the application.</p> <p>c. Save the script.</p> <p>d. In the Connectivity Wizard, click Cancel to exit without sending the script at this time.</p> <p>e. If you have not already done so, turn ON the printer.</p> <p>f. Send the ZPL file to the printer through the connection of your choice.</p>

16. Observe the wireless status on the printer's indicator lights, and confirm that you have set up your printer for wireless connectivity.

Bluetooth Option Configuration

The Zebra Setup Utilities provides a quick and easy way to configure a Bluetooth wireless connection with your printer.

1. Double-click the Zebra Setup Utilities icon on your desktop.
2. Connect a USB cable from your printer to your computer.
3. On the first ZSU screen, highlight the printer displayed in the window and click on the Configure Printer Connectivity where shown.
4. Select 'Bluetooth' on the Connectivity Type screen and click on the Next button.



5. On the Bluetooth Settings screen, check "Enabled" to enable Bluetooth functionality.
6. In the Friendly Name text field, set the Bluetooth name of the device. This name appears during device discovery and the master device will label the printer with this name.
7. Set Discoverable to "On" or "Off" to set whether the device will appear when master devices are looking for new devices to pair with.
8. Set Authentication to "On." (Note: This setting does not exist in Link-OS, but you need to turn on if you want to enter a PIN in ZSU. Actual authentication setting on the printer is set in the Security Mode on the Advanced Settings menu.)

- The values set in the Authentication PIN field will vary depending on the Bluetooth version of the master device. If the master uses BT v2.0 or older, enter a numeric value in this field. You will be prompted to enter this same value on the master device to verify pairing. Security Mode 2 or 3 in Advanced Settings should also be selected for PIN pairing.



- If the master device uses BT v2.1 or newer, this setting has no effect. BT v2.1 and newer uses Secure Simple Paring (SSP) which does not require the use of a PIN.
- Clicking on the Advanced Settings button will display the Advanced Bluetooth Settings window. For more information on Advanced Settings, refer to the **Wired and Wireless Print Server Guide**.
- Click Next to continue configuring your printer.
- The SGD commands to properly configure your printer will be displayed. Click Next to continue to the Send Data screen.
- On the Send Data screen, you may click on the Printer that you want to immediately send the commands to or you may click on the File button to save the commands to a file on your computer that can be sent to one or more printers at a later time.
- To send the commands to the printer, click on the Finish button and the printer will be updated and then reboot. You may disconnect the USB interface from your printer now.
- To complete the Bluetooth pairing process, enable Bluetooth device discovery on your master device and follow the directions provided with the master device.

Connecting to a Windows XP® SP2 Master Device

This process covers the printer installation for Windows XP SP2 (or above)

1. From the Windows 'Start' menu, open the 'Printers and Faxes' window. Click on 'Add Printer' and a wizard will start. Click 'Next' when the "Welcome" window displays to continue.
2. Leave the 'Local' radio button with the 'Automatic detect ...' checkbox (checked) selected and click 'Next'.
3. No printer should be found. If there is one or more new printers detected, then do not select any of those printers and click 'Next'.
4. Select the 'Create a new port' radio button and select 'Bluetooth Printer Port' from the associated pull down menu.
5. From the new 'Bluetooth Printer Port' window, select your printer from the Bluetooth devices in the list. This may take several minutes. Click on the 'Connect' button.
6. The 'Install Printer Software' window will open. Select 'ZDesigner' as 'Manufacture' to select supported Zebra printer models, and then select your printer model in the 'Printers' selection. Click 'Next' to continue.
7. Select 'Keep the existing drivers' and click 'Next'.
8. Name your printer and choose your default printer setting as desired. Click 'Next'.
9. Answer 'Yes', you want to print a test page. Click 'Next' to continue.
10. Click 'Finish' on the 'Completing the Add Printer Wizard' window and the Bluetooth printer will complete installation and print a Windows test print page (a Windows logo at minimum).

Connecting to a Windows Vista® SP2 or Windows 7® Master Device

The Windows Vista (SP2 or higher) and Windows 7 Bluetooth install differs from the XP install.

- **Windows Vista:** Open the 'Add Printer' wizard by clicking the 'Start' button, clicking 'Control Panel', clicking 'Hardware and Sound', clicking 'Printers', and then clicking 'Add a printer'.
- **Windows 7:** Open Devices and Printers by clicking the 'Start' button, and then, on the 'Start' menu, clicking 'Devices and Printers'
- Some non-Microsoft Bluetooth dongles and built-in Bluetooth devices in the host PC's have marginal driver support for Secure Simple Pairing (SSP) printing and may not complete the 'Add printer' wizard normally. You may need to go to the 'Bluetooth Devices' in the 'Control Panel' or from the system tray on the Windows 'Start' bar and activate SPP for the 'device', your Bluetooth printer you are installing. Install the printer to a local printer (USB or Serial Port for your ZD420 printer) and then change the 'Port' after the install has completed to the SPP (virtual serial port) COM port.

1. Access the 'Devices and Printers' from the Windows Start menu ().
2. Check for Bluetooth devices in the 'Devices and Printers' window. Note the generic Windows Bluetooth icon below.

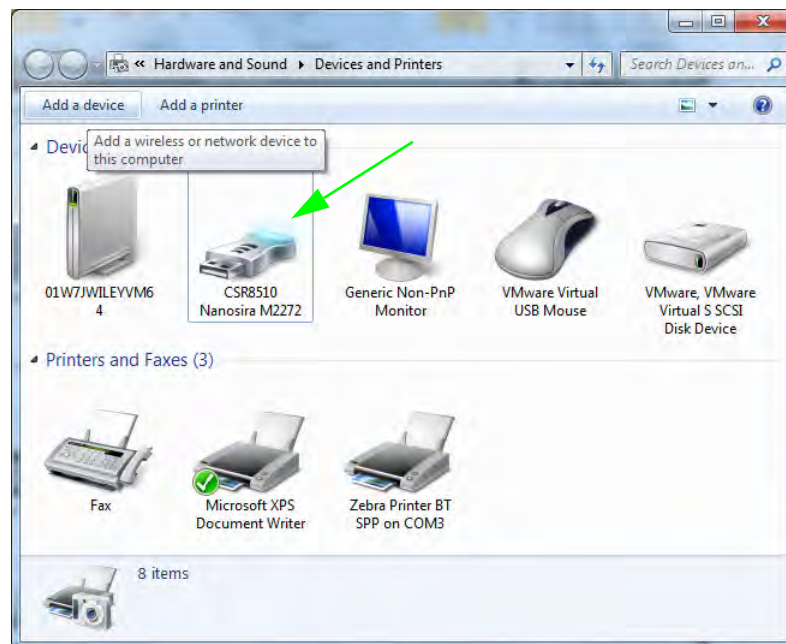

3. Hover over the Bluetooth icon with the mouse pointer and the icon will highlight. Right-Click on the high-lighted Bluetooth icon. Select 'Bluetooth Settings' from the pop-up menu. Verify that both of the Connections check boxes are checked. Verify that the 'Turn off the Bluetooth adapter' is not checked. Click the 'Apply' button. Click the 'OK' button to close the window.

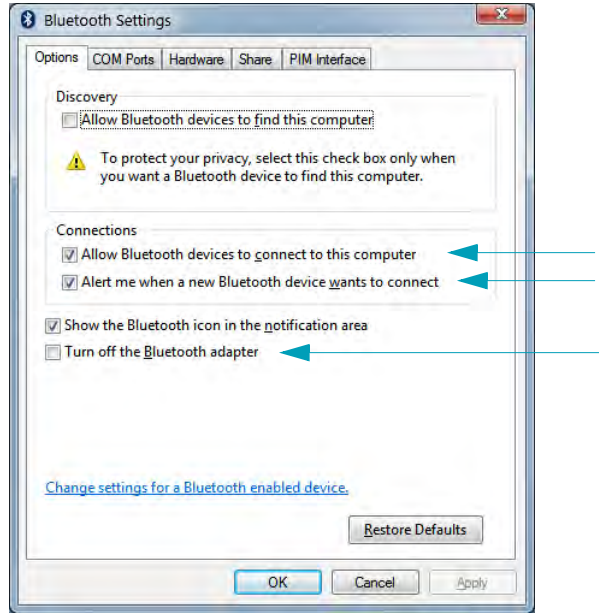

4. Click on the 'Add a device' in the top bar of the "Devices and Printers" window. After a few moments the "Add a device" windows will populate with Bluetooth devices near you.
5. Turn the Bluetooth 4.0 (3.0 compatible) enabled Zebra printer on. After a few moments the "Add a device" windows will add your new printer. Click on the printer icon. Right-Click and select 'Add device'.

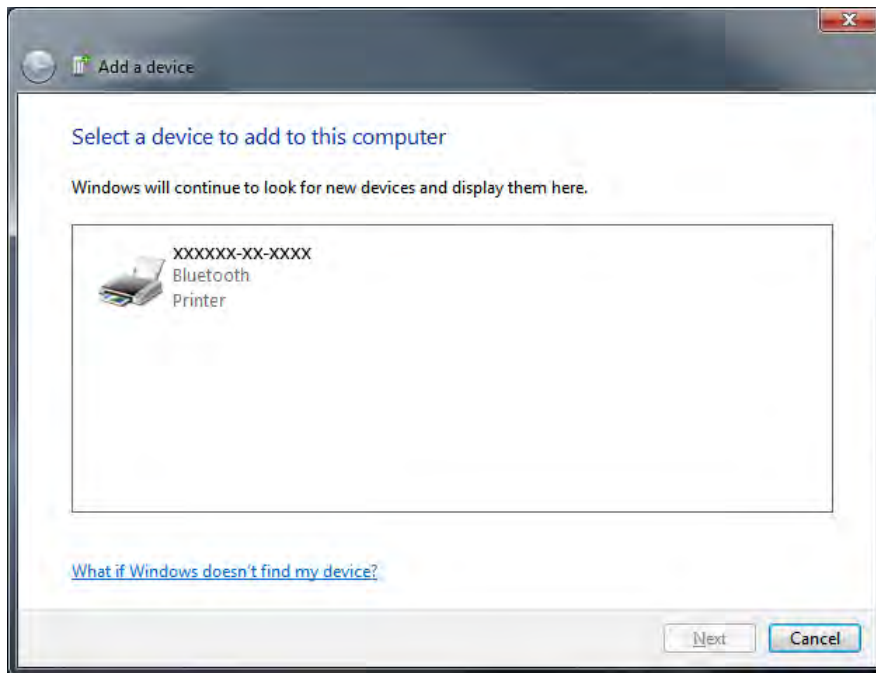

- The printer will print a pairing code. Verify that the pairing numbers match with those on your display screen.
 If the numbers match, then press the 'Next button' in the 'Add a device' window.

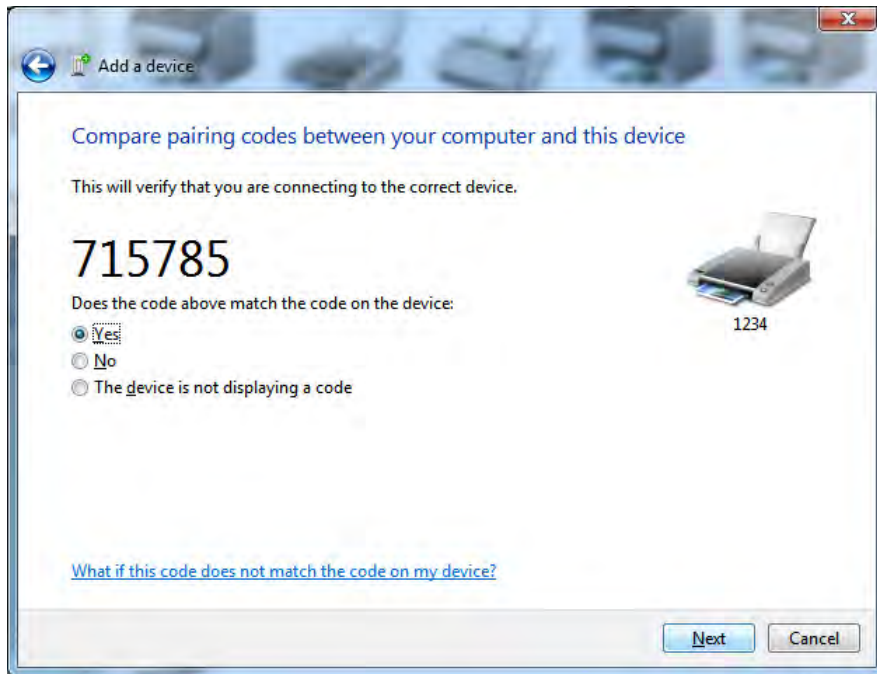

- When the pairing process successfully completes, the following message will be displayed.

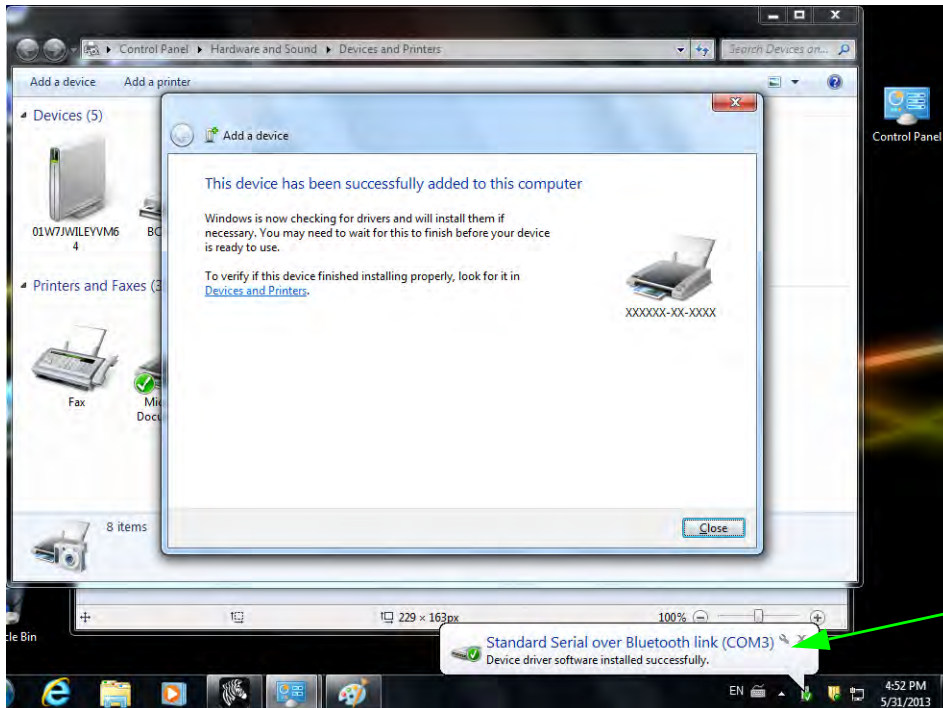

Note • Note the COM port number displayed in the task bar pop-up. It will only remain for a few seconds.

Connecting the Printer to a Windows 8

Before adding (also called pairing) a Bluetooth enabled device, make sure it is turned on and discoverable. As stated in the previous section under *Connecting to a Windows Vista® SP2 or Windows 7® Master Device on page 63*, your Windows device may need a Bluetooth adapter to connect to Bluetooth device. Check with your device manufacturer's User Manual for further information.

1. Swipe in from the right edge of the screen or move your mouse towards the right edge of the screen, select **Settings**, and then select **Change PC Settings**.

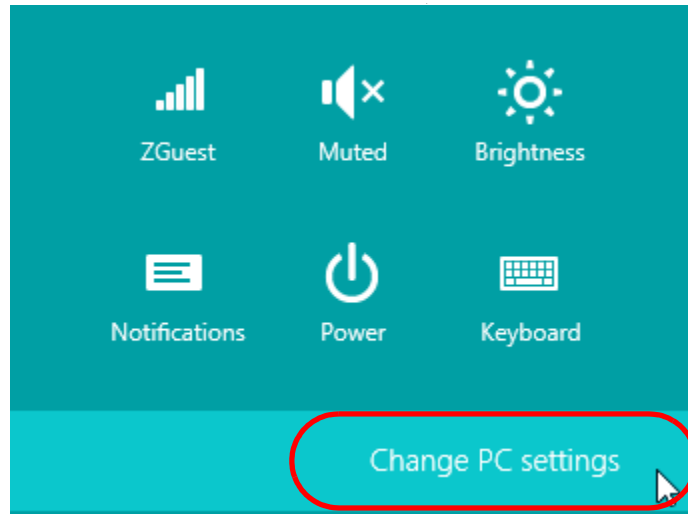

2. Select **PC and devices**, and then select **Bluetooth**. Once Windows displays the Bluetooth-enabled devices, select the device and click **Pair**.

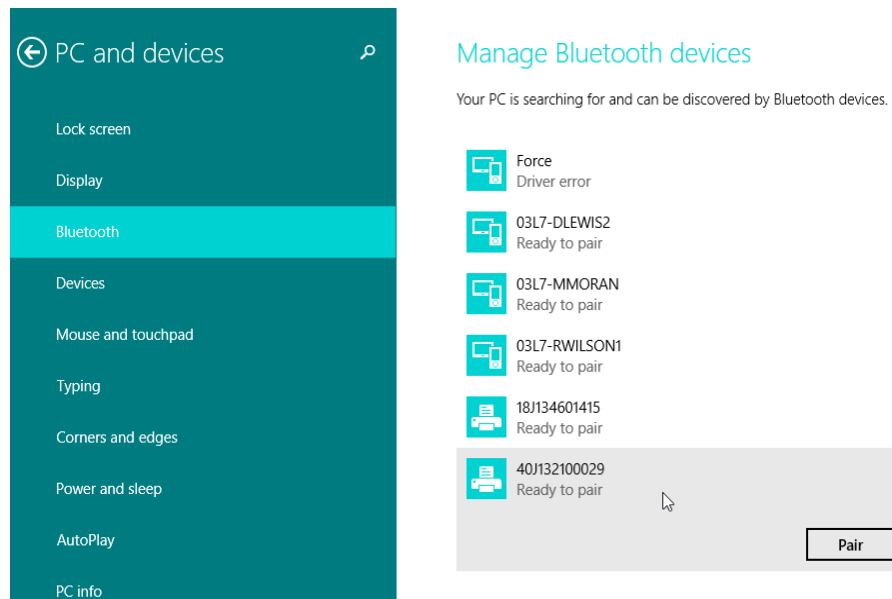

Important • Windows will display the pairing code for only 10 seconds, so complete this step quickly!

3. Follow the instructions on your screen to finish pairing your device.

Connecting the Printer to a Windows 10 PC

Before adding (also called pairing) a Bluetooth enabled device, make sure it is turned on and discoverable. As stated in the previous section under “Installing the Printer on a Windows 7 PC,” your Windows device may need a Bluetooth adapter to connect to Bluetooth device. Check with your device manufacturer’s User Manual for further information.

1. Open the Windows Start Menu by clicking on the Windows Start () button and select **Settings**.

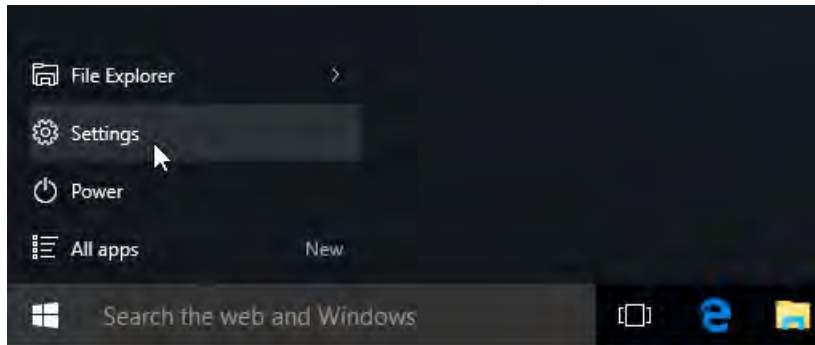

2. Click on the **Devices** category in the Settings window.

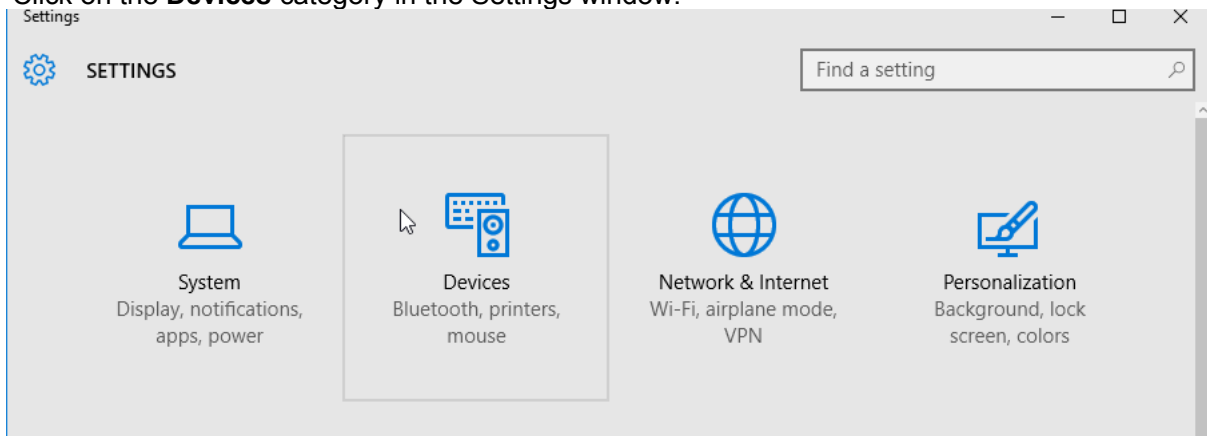

3. Click on Bluetooth. If your PC doesn’t have Bluetooth installed, the Bluetooth category will not be displayed in the list of device categories. The printer is identified by the serial number.

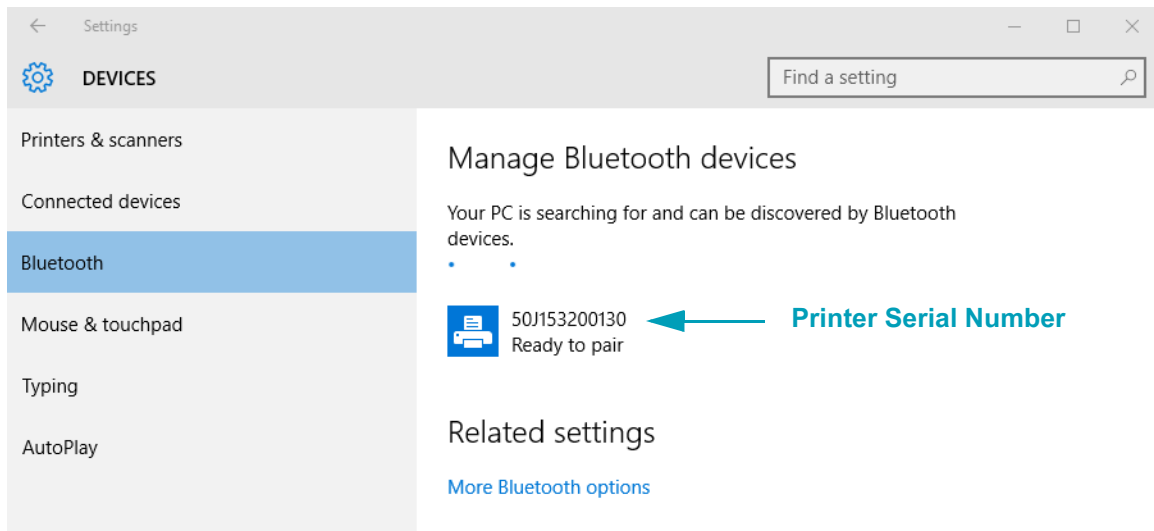

- Click on the printer and then click on the 'pairing' button for the printer.

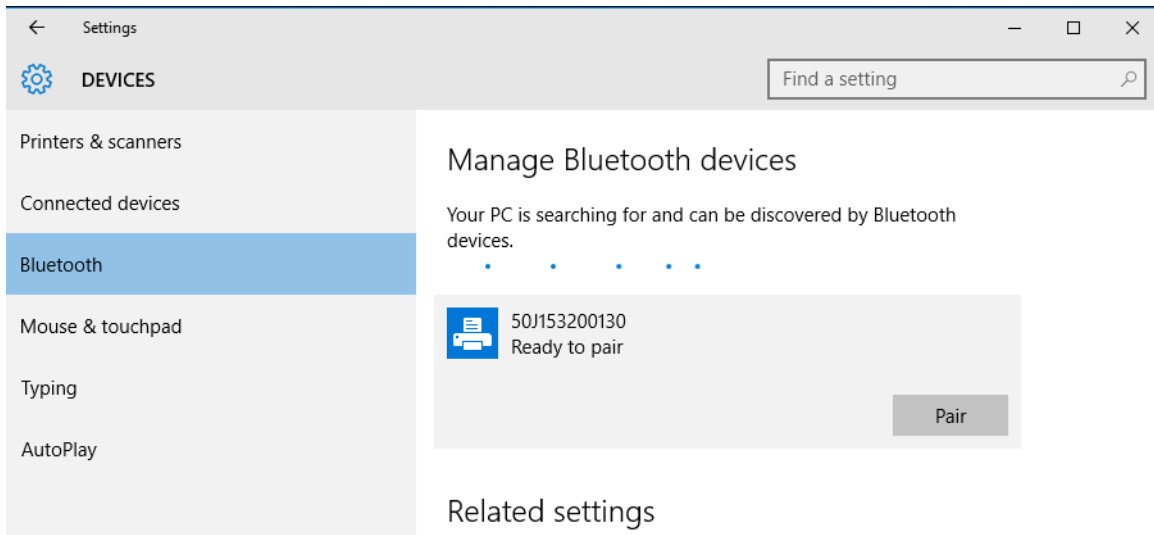

- The printer will print a passcode. Compare that with the passcode showing on screen. Click 'Yes' if they match.

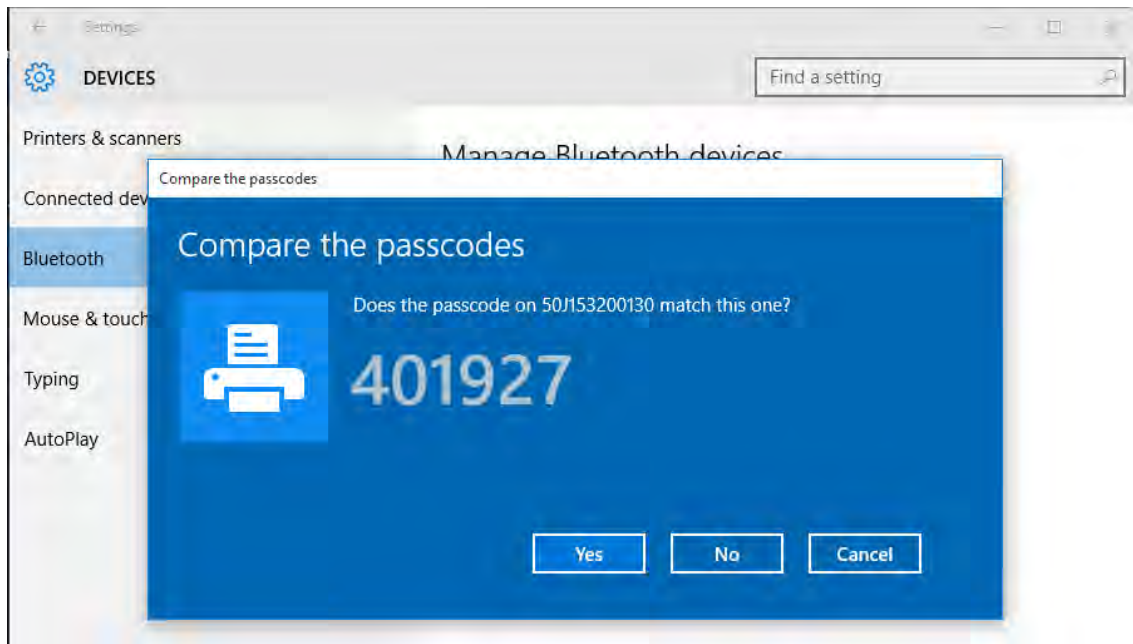

- The printer status changes to connected when pairing has completed.

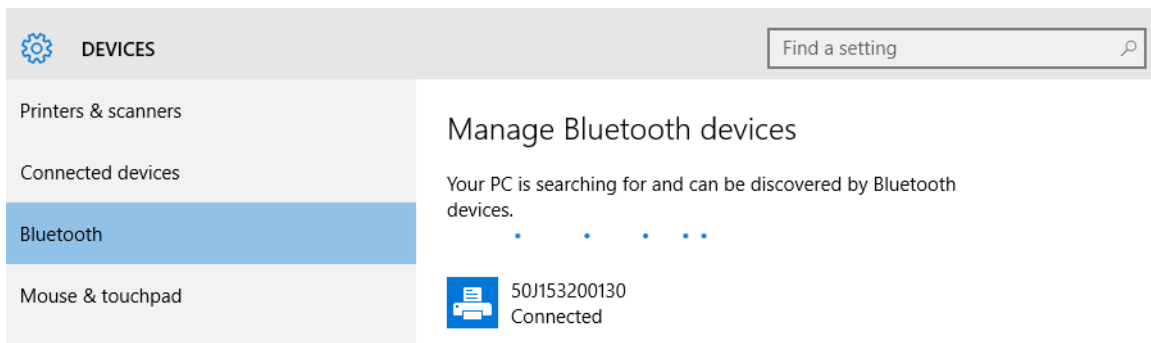

After Your Printer is Connected

Now that you have basic communication to your printer, you may want to test printer communications and then install other printer related applications, drivers or utilities.

Testing Communications by Printing

Verifying the print system's operation is a relatively simple process. For Windows operating systems, use the Zebra Setup Utility or the Windows 'Printers and Faxes' Control Panel to access and print a test label. For non-Windows operation systems, copy a basic ASCII text file with a single command (~wC) to print a configuration status label.

Test Printing with Zebra Setup Utility:

1. Open the Zebra Setup Utility.
2. Click on the newly installed printer's icon to select the printer and activate the printer configuration buttons below it in the window.
3. Click the 'Open Printer Tools' button.
4. In the 'Print' tab window, click on the 'Print configuration label' line and click on the 'Send' button. The printer should print a configuration report.

Test Printing with Windows 'Printer and Faxes' menu:

1. Click on the Windows 'Start' menu button, to access the 'Printers and Faxes' menu or 'Control Panel' to access the 'Printers and Faxes' menu. Open the menu.
2. Select the newly installed printer's icon to select the printer and right-click the mouse to access the printer 'Properties' menu.
3. From the printer's 'General' tab window, click on the 'Print Test Page' button. The printer should print a Windows test print page.

Test Print with an Ethernet printer connected to a network

Test Print on an Ethernet printer connected to a network (LAN or WLAN) with a (MS-DOS) 'Command Prompt' (or 'Run' from the Windows XP Start menu):

1. Create a text file with the following ASCII three characters: ~wC
2. Save the file as: TEST.ZPL (an arbitrary file name and extension name).
3. Read the IP address off the printer's Configuration Report's Network Status printout. On a system that is connected to the same LAN or WAN as the printer, type the following in the Web browser window's address bar and enter:
`ftp (IP address)`
(for IP address 123.45.67.01 it would be: `ftp 123.45.67.01`)
4. Type the word 'put' followed by the file name and enter. For this 'test print' file, it would be:
`put TEST.ZPL`
The printer should print a new Print Configuration Report.

Test Print with a Copied ZPL Command File for Non-Windows Operating Systems:

1. Create a text file with the following ASCII three characters: ~wC
2. Save the file as: TEST.ZPL (an arbitrary file name and extension name).
3. Copy the file to the printer. For DOS, a file sent to a printer connected to the system's serial port would be as simple as:

```
COPY TEST.ZPL COM1
```

Other interface connection types and operating systems will have different command strings. See your operating system documentation for detailed instructions to copy to the appropriate printer interface for this test.

Print Operations

This section provides media and print handling, font and language support, and the setup of less common printer configurations.

Thermal Printing



Caution • The printhead becomes hot while printing. To protect from damaging the printhead and risk of personal injury, avoid touching the printhead. Only use the cleaning pen to perform printhead maintenance.



Caution • The discharge of electrostatic energy that accumulates on the surface of the human body or other surfaces can damage or destroy the printhead or electronic components used in this device. You must observe static-safe procedures when working with the printhead or the electronic components under the top cover.

Determining Your Printer's Configuration Settings

The ZD420 printer uses the configuration report to provide the printer settings. Operational status (darkness, speed, media type, etc.), installed printer options (network, interface settings, cutter, etc.) and printer description information (serial number, model name, firmware version, etc.) are all included on the configuration report.

See [Test Printing with the Configuration Report on page 41](#) to print this label.

See [Managing the ZPL Printer Configuration on page 145](#) to help interpret the configuration report and the associated programming command and command states it is identifying in the report.

Replacing Supplies

If media (ribbon, labels, receipts, tags, tickets, etc.) run out while printing, leave the printer power on while reloading (data loss results if you turn off the printer). After you load a new media, press the Feed button to restart.

Adjusting the Print Quality

Print quality is affected by the heat (density) setting of the printhead, the print speed, and the media in use. Experiment with these settings to find the optimal mix for your application. Print quality can be configured with the Zebra Setup Utility's 'Configure Print Quality' routine.



Note • Media manufacturers may have specific recommendations for speed settings for your printer and the media. Some media types have lower maximum speeds than your printer's maximum speed.

The darkness (or density) setting can be controlled by:

- The Set Darkness (~SD) ZPL command (consult your ZPL Programming Guide).
- See the [Manual Print Darkness Adjustment on page 111](#)
- See the [Operator Darkness Control on page 96](#)

If you find that the print speed needs to be adjusted, use:

- The Windows printer driver or application software such as ZebraDesigner™.
- The Print Rate (^PR) command (consult your ZPL Programming Guide).

Use the printer's 'Print Quality Report' (also known as the FEED Self Test) to print a range of labels that help you identify print DARKNESS and SPEED settings for optimizing general print and barcode quality. See the [Print Quality Report \(FEED self test\) on page 101](#) for details.

The printer's media settings can be verified by printing a Printer Configuration label. See the [Test Printing with the Configuration Report on page 41](#) for more details.

The maximum distance that the automatic media type detection and sensing will check can be reduced by using the ZPL Maximum Label Length command (^ML). It is recommended that this distance be set to no less than two times the longest label being printed. If the largest label being printed was a 2 by 6 inch label, then the maximum label (media) length detection distance can be reduced from the default distance of 39 inches down to 12 inches.

Adjusting the Print Width

Print width must be set:

- Before you use the printer for the first time.
- Any time you change the width of the media in use.

Print width may be set by:

- The Windows printer driver or application software such as ZebraDesigner™.
- Controlling printer operations with ZPL programming; refer to the Print Width (^PW) command (consult your ZPL Programming Guide).

Printing on Fan-Fold Media

Printing on fan-fold media requires you to adjust the media guides stop position.

1. Open the top cover.

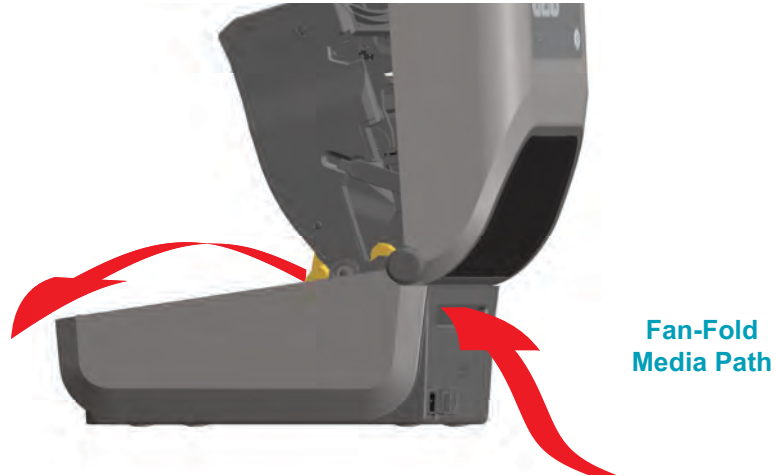

2. Adjust the media guide stop position with the gold thumb wheel. Use a piece of the fan-fold media to set the stop position. Rotate the wheel away from you to make the guides wider. Rotate the wheel toward you to make the media guides narrower.

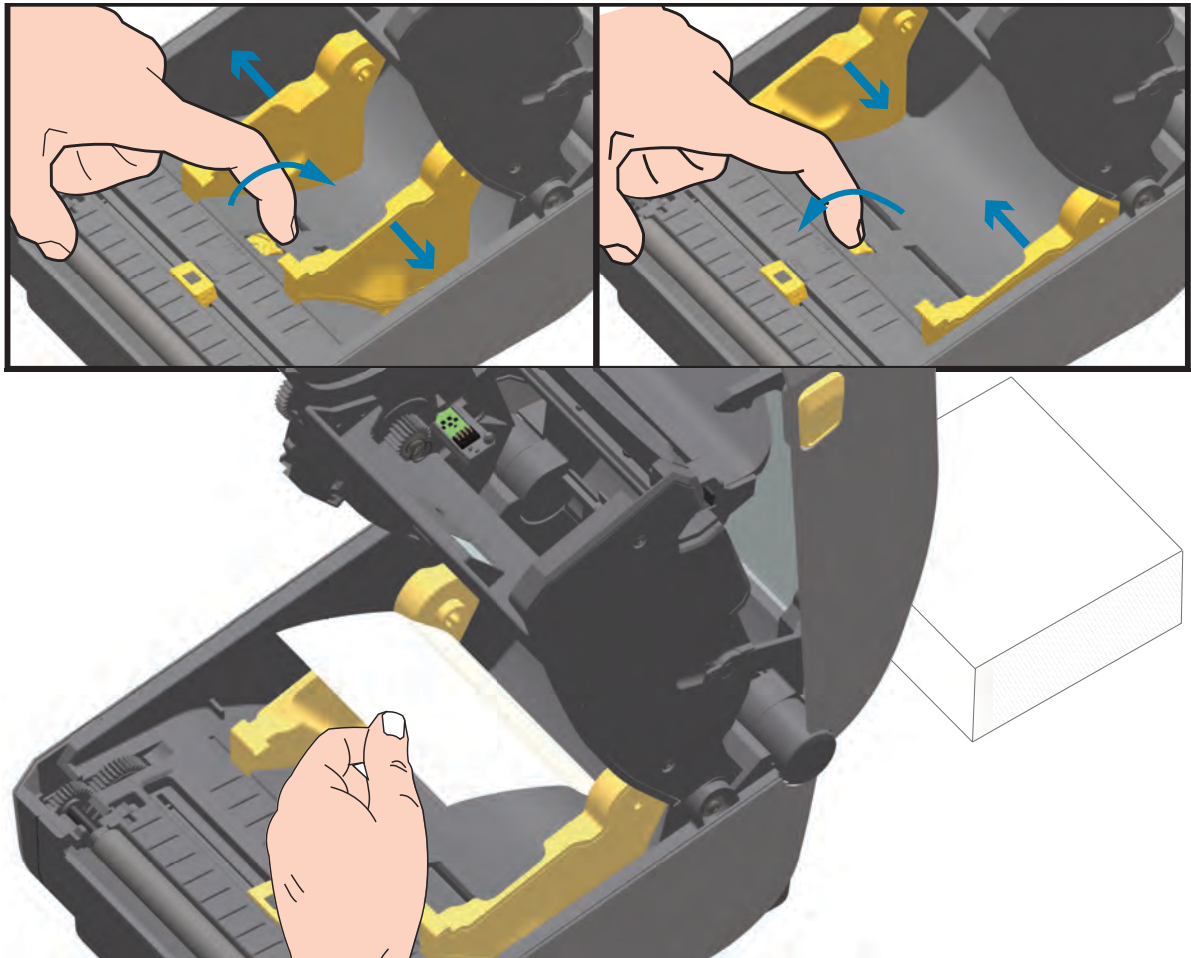

3. Insert the media through the slot at the rear of the printer and place the media between the media guide and roll holders.



4. Close the top cover.

After printing or feeding several labels: If the media does not track down the center (moves from side to side) or the sides of the media (liner, tag, paper, etc.) are frayed or damaged when exiting the printer, then the media guides may need further adjustment. If this does not correct the problem, then the media can be routed over the two roll holding pins on the media guide. An empty roll core of the same width as the stack of the fan-fold media can be placed between the roll holders to provide additional support for thin media.

Printing with Externally Mounted Roll Media

The printer accommodates externally mounted roll media similar to the printer's support of fan-fold media. The printer requires the media roll and stand combination to have a low initial inertia to pull the media off the roll.

Zebra at this time does not offer an external roll media option for the ZD420 printer.

Externally Mounted Roll Media Considerations:

- The media ideally should enter the printer directly behind the printer through the fan-fold media slot in the rear of the printer. See [Printing on Fan-Fold Media on page 73](#) for media loading.
- Lower the print speed to decrease the chance of motor stalls. The roll typically has the highest inertia when trying to start the roll moving. Larger media roll diameters require the printer to have more torque applied to get the roll moving.
- The media should move smoothly and freely. The media should not slip, skip, jerk, bind and then move, etc. when mounted on your media stand.
- The printer should not touch the media roll.
- The printer should not slip or lift up off the operating surface.

Using the Label Dispenser Option

The label dispenser option allows you to print a label and have the backing material (liner/web) automatically removed. When printing multiple labels, removing the dispensed (peeled) label triggers the printer to print and dispense the next label.

To use dispenser-mode, set 'Media Handling' to 'Peel-Off' in the printer driver or with the Zebra Setup Utility using the 'Configure Printer Settings' wizard. Otherwise, you must send the ZPL programming commands to the printer.

When programming in ZPL, you can use the command sequences shown below to configure the printer to use the dispenser option:

```
^XA ^MMP ^XZ
^XA ^JUS ^XZ
```

1. Load your labels into the printer. Close the printer and press the Feed button until a minimum of 100 millimeters or 4 inches of exposed labels exit the printer. You can leave the labels on the liner.



2. Lift the liner over the top of the printer. Pull the gold latch in the center of dispenser door away from the printer and the door will open.

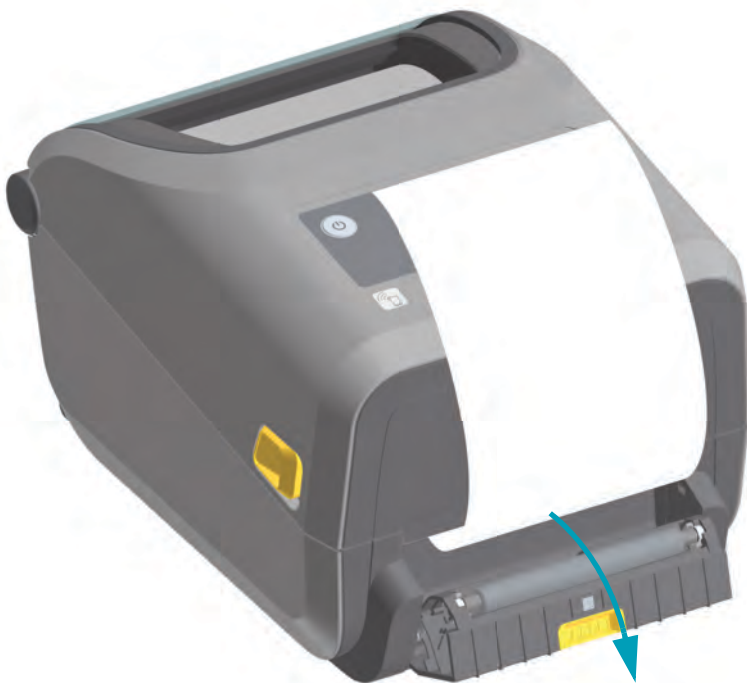

3. Insert the label liner between the dispenser door and the printer body.



4. Close the dispenser door while pulling the end of the label liner tight.



5. Press and release the Feed (Advance) button one or more times until a label gets presented for removal. Repeat one more time and then tear the exposed liner exiting from the bottom of the label dispenser.



6. During the print job, the printer will peel off the backing and present a single label. Take the label from the printer to allow the printer to print the next label. Note: If you did not activate the label taken sensor to detect the removal of the dispensed (peeled) label with software commands, the printer will stack and eject peeled labels.

Sending Files to the Printer

Graphics, fonts and programming files can be sent to the printer from the Microsoft Windows operating systems by using the Link-OS Profile Manager, Zebra Setup Utilities (and driver), ZebraNet™ Bridge or Zebra® ZDownloader found on the user's CD or at www.zebra.com.

Printer Fonts

The ZD420 printer supports your language and font requirements with a variety of internal fonts, on-board font scaling, international font sets and character code page support, Unicode support, and font download.

The printer's font capabilities are programming language dependent. The ZPL™ programming language provides advanced font mapping and scaling technology to support outline fonts (TrueType™ or OpenType™) and Unicode character mapping as well as basic bitmapped fonts and character code pages. The ZPL programming guide describes and documents the fonts, code pages, character access, listing fonts, and limitations for their respective printer programming languages. See the printer programming guides for information on Text, Fonts and Character support.

The printer includes utilities and application software that support font download into the printer for both printer programming languages.

Identifying Fonts in Your Printer

Fonts and memory are shared by the programming languages in the printer. Fonts can be loaded into various storage locations in the printer. ZPL programming can recognize EPL and ZPL fonts. EPL programming can only recognize EPL fonts. See the respective programmer guides for more information on fonts and printer memory.

ZPL Fonts:

- To manage and download fonts for ZPL print operation, use the Zebra Setup utility or ZebraNet™ Bridge.
- To display all of the fonts loaded in your printer, send the printer the ZPL command `^WD`. See the ZPL Programmers Guide for details.
 - Bitmap fonts in the various printer memory areas are identified by the `.FNT` file extension in ZPL.
 - Scalable fonts are identified with the `.TTF`, `.TTE` or `.OTF` file extensions in ZPL. EPL does not support these fonts.

Localizing the Printer with Code Pages

The ZD420 printer supports two sets of language, region and character sets for permanent fonts loaded into the printer for each printer programming language, ZPL and EPL. The printer supports localization with common international character map code pages.

- For ZPL code page support, including Unicode, see the `^CI` command in the ZPL programmer's guide.

Asian fonts and Other Large Font Sets

Asian language ideographic and pictographic fonts have large character sets with thousands of characters that support single language code page. In order to support the large Asian character sets, the industry adopted a double-byte (67840 maximum) character system instead of the single-byte characters (256 maximum) used by Latin based language characters to address large font sets. In order to address multiple languages with a single font set, Unicode was invented. A Unicode font supports one or more code points (relate these to code page character maps) and is accessed in a standard method that resolves character mapping conflicts. The ZPL programming language supports Unicode. Both of the printer's programming languages support the large pictographic double-byte character Asian font sets.

The number of fonts that can be downloaded is dependent upon the amount of available flash memory not already in use and the size of the font to be downloaded.

Some Unicode fonts are large such as MS (Microsoft) Arial Unicode font (23 MB) available from Microsoft or the Andale font (22 MB) offered by Zebra. These large font sets typically support a large number of languages as well.

Getting Asian Fonts

Asian bitmap font sets are downloaded into the printer by the user or integrator. The ZPL fonts are purchased separately from the printer. EPL Asian Fonts are available for free to download from the Zebra Web site.

- Simplified and Traditional Chinese
(The SimSun font is pre-loaded in printers sold in the Peoples Republic of China)
- Japanese — JIS and Shift-JIS mappings
- Korean including Johab
- Thai

Zebra® ZKDU — Printer Accessory

The Zebra® ZKDU (keyboard display unit) is a small terminal unit that interfaces with the printer for accessing EPL or ZPL label forms stored in the printer.

The ZKDU is strictly a terminal and does not have the capability to store data or set up parameters.

The ZKDU is used for the following functions:

- List label forms stored in printer
- Retrieve label forms stored in printer
- Input variable data
- Printing labels
- Switching between EPL and ZPL to dual support both printer language format/form types that can be stored and printed in many later model Zebra label printers.

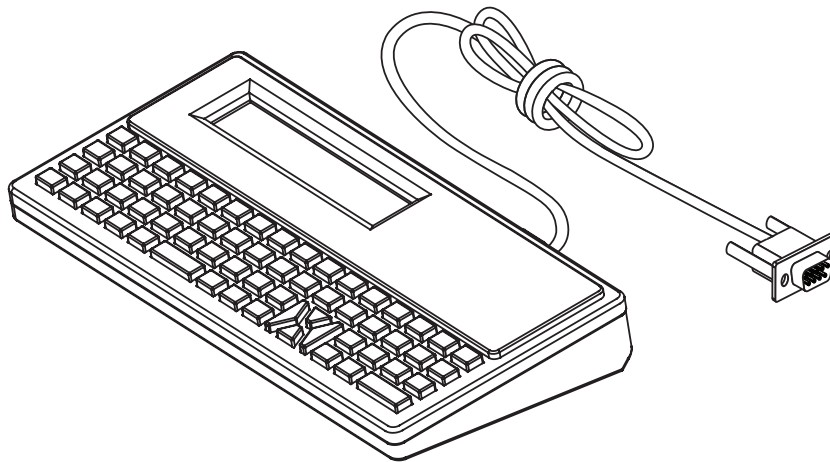

ZBI 2.0™ — Zebra Basic Interpreter

Customize and enhance your printer using the ZBI 2.0™ programming language. ZBI 2.0 allows Zebra printers to run applications and take input from scales, scanners and other peripherals without a PC or network connection. ZBI 2.0 works with the ZPL printer command language so that printers can understand non-ZPL data streams and convert them into labels. That means the Zebra printer can create barcodes and text from input received, non-ZPL label formats, sensors, keyboards and peripherals. Printers can also be programmed to interact with PC based database applications to retrieve information to be used on printed labels.

ZBI 2.0 can be activated by ordering a ZBI 2.0 Key Kit, or activated by purchasing a key from the ZBI 2.0 store at www.zebra.com/software.

Use the ZDownloader utility to apply the key. ZDownloader is available on the users CD or at the Zebra Web site: www.zebra.com.

An intuitive ZBI-Developer™ programming utility is used to create, test and distribute ZBI 2.0 applications is available on the users CD or at the Zebra Web site: www.zebra.com.

Troubleshooting

This section provides troubleshooting procedures and information.

Meaning of the Indicator Light Patterns

The indicators on the control panel show the current status of the printer.

Table 1 • Status of Printer As Shown by Indicator Lighting Patterns







































































Typical Operating Conditions					 Steady  Flashing  Fade
STATUS	PAUSE	DATA	SUPPLIES	NETWORK	
					The printer is ready.
					The printer is paused.
					The media supply is out. The printer needs attention and cannot continue without user intervention.
					Ribbon In - The printer is in direct thermal mode and has a ribbon cartridge installed. Remove the ribbon cartridge to continue printing in direct thermal mode.
					Ribbon Low - Default is 10% of ribbon remaining. The Media indicator flashes red and yellow while the Status indicator is solid yellow.
					Ribbon Out - missing ribbon cartridge or the ribbon cartridge needs replaced to continue printing when the printer is in thermal transfer mode.
					A data communication operation has not finished, but is not actively being transferred.
					Data communications are in process.
Special Error Conditions					
					There is a jam in the cutter.
					The printhead is open. The printer needs attention and cannot continue without user intervention.
					The printhead is over temperature.  Caution • The printhead may be hot and could cause severe burns. Allow the printhead to cool.
					The printhead is over temperature. Turn the printer OFF. After several minutes to allow the printer to completely cool, turn the printer ON.  Caution • The printhead may be hot and could cause severe burns.
					The printhead is under temperature.

Table 1 • Status of Printer As Shown by Indicator Lighting Patterns

















































































Typical Operating Conditions					 Steady  Flashing  Fade
STATUS	PAUSE	DATA	SUPPLIES	NETWORK	
					The printhead was replaced with one that is not a genuine Zebra printhead. Install a genuine Zebra printhead to continue.
					The printer is unable to read the printhead type (dpi). The printhead has been replaced incorrectly or with a non-Zebra printhead. Call a service technician.
					Out of memory while storing content (formats, graphics, fonts, etc.).
					The ribbon cartridge can not be authenticated or has been altered. The printer only supports Genuine Zebra Ribbon Cartridges and does not support refurbished or non-Zebra cartridges.
Printers with a Bluetooth Low Energy option					
					Bluetooth Low Energy has paired.
					Bluetooth Low Energy has failed to pair.
Printers with an Ethernet (LAN) option					
					NETWORK light off No Ethernet link is available.
					A 100 Base link was found.
					A 10 Base link was found.
					An error condition exists. The printer is not connected to your network.
Printers with a Wi-Fi (WLAN) option					
					The light flashes red while the printer associates with the network.
					The light then flashes yellow while the printer is authenticating with the network.
					The printer is connected to your network and the WiFi signal is strong.

Table 1 • Status of Printer As Shown by Indicator Lighting Patterns

Typical Operating Conditions					
STATUS	PAUSE	DATA	SUPPLIES	NETWORK	Steady  Flashing  Fade 
					The printer is connected to your network and the WiFi signal is weak.
					An error condition exists. The printer is not connected to your network.

Printing Issues

This section helps you identify issues with printing or print quality, the possible causes, and the recommended solutions.

Table 2 • Printing Issues

Issue	Possible Cause	Recommended Solution
General print quality issues - The printed image does not look right.	The printhead is dirty.	Clean the printhead. See Cleaning the Printhead on page 115 and Platen Cleaning and Replacement on page 124
	The printer is set at an incorrect darkness level and/or print speed.	Perform the Print Quality Report (FEED self test) on page 101 to determine the ideal darkness and speed settings for your application. Do not set print speeds above the manufacturer's maximum rated speed for your media (print material and ribbons both).
	You may be using the wrong power supply.	Verify you are using the power supply that came with this printer.
	The printhead has worn out.	Replace the printhead. The printhead is a consumable item and which will wear over time due to friction between the media and printhead. Using unapproved media may shorten printhead life or damage your printhead.
	The platen (drive) roller may need cleaning or replacement.	Clean or replace the platen (drive) roller.
	Thermal Transfer printing - You may not be using the correct ribbon cartridge type.	The print material (wax, wax-resin, or resin) may not match the material (paper, media coating, or synthetics) in use.
	Thermal Transfer printing - Voids or holes in print with no particular pattern.	The print material (wax, wax-resin, or resin) or print speed may not match the material (paper, media coating, or synthetics) in use. Set the printer for no higher than the maximum recommended print speed of the ribbon cartridge. See Ribbon Cartridge Programming Commands on page 95 for reading cartridge features.
No print on the label.	The media may not be direct thermal media (and is thermal media made for thermal transfer printers).	See the test procedure Determining Thermal Media Types on page 141 .
	Media has been loaded incorrectly.	The media printable surface must face up towards the printhead. Follow the instructions for Loading Roll Media on page 32 in the Setup section.

Table 2 • Printing Issues (Continued)

Issue	Possible Cause	Recommended Solution
Loss of printing registration on labels. Excessive vertical drift in top-of-form registration.	The platen (drive) roller is dirty.	Clean the printhead and platen roller. Cleaning the Printhead on page 115 and Platen Cleaning and Replacement on page 124
	The media type is set incorrectly.	Set the printer for the correct media type (gap/notch, continuous, or mark). See Run a SmartCal Media Calibration on page 40 . or if it still skips labels try a Manual Media Calibration on page 109 .
	The media is loaded incorrectly.	Load media correctly. See Loading Roll Media on page 32 .
Long tracks of missing print on several labels	Printhead element damaged.	Call a service technician.
Printing too light or too dark over the entire label	The media or ribbon is not designed for high-speed operation.	Replace supplies with those recommended for high-speed operation.
Smudge marks on labels	The media is not designed for high-speed operation.	Replace supplies with those recommended for high-speed operation.
Mis-registration/ skips labels	The printer is not calibrated.	Calibrate the printer. See Run a SmartCal Media Calibration on page 40 . or if it still skips labels try a Manual Media Calibration on page 109 .
	Improper label format.	Check your label format and correct it as necessary.
Vertical drift in top-of-form position	The printer is out of calibration.	Calibrate the printer. See Run a SmartCal Media Calibration on page 40 .
	The platen (drive) roller is dirty.	Clean the printhead and platen roller. See Cleaning the Printhead on page 115 and Platen Cleaning and Replacement on page 124

Table 2 • Printing Issues (Continued)

Issue	Possible Cause	Recommended Solution
Vertical image or label drift	The printer is using non-continuous labels but is configured in continuous mode.	Set the printer for the correct media type (gap/notch, continuous, or mark) and calibrate the printer (Run a SmartCal Media Calibration on page 40), if necessary (see Manual Media Calibration on page 109).
	The media sensor is calibrated improperly.	Calibrate the media in the printer. See Manual Media Calibration on page 109 .
	The platen (drive) roller is dirty.	Clean the printhead and platen roller. See Cleaning the Printhead on page 115 and Platen Cleaning and Replacement on page 124 .
	The media is loaded incorrectly.	Ensure that the media is loaded correctly. See Loading Roll Media on page 32 and Test Printing with the Configuration Report on page 41 .
	Incompatible media.	You must use media that meets the printer specifications. Ensure that the inter-label gaps or notches are 2 to 4 mm and consistently placed.
The barcode printed on a label does not scan.	The barcode is not within specifications because the print is too light or too dark.	Perform the Printer Network Configuration Report on page 99 . Adjust the darkness or print speed settings as necessary.
	There is not enough blank space around the barcode.	Leave at least 1/8 in. (3.2 mm) of blank space around the barcode (referred to as the quiet zone) and other printed areas on the label and between the barcode and the edge of the label. This requirement varies by barcode type.
	There is a void or missing print in a barcode, text, or graphic in a printed form. Voids can look like a white bar area in a barcode.	<ol style="list-style-type: none"> 1. Perform Cleaning the Printhead on page 115 to remove contaminants on the printhead. Reprint and test the barcode. 2. The print material and transfer ribbon type may not match - causing random voids. 3. Use the Printer Network Configuration Report on page 99 to see if the printhead has damaged printhead elements. Verify that the large black bar on the bottom of the printed test label does not have any streaks or voids after thoroughly cleaning the printhead. Call a service technician.

Communications Problems

Table 3 identifies problems with communications, the possible causes, and the recommended solutions.

Table 3 • Communications Problems

Problem	Possible Cause	Recommended Solution
A label format was sent to the printer but was not recognized. The DATA light does not flash.	The communication parameters are incorrect.	Check the printer driver or software communications settings (if applicable).
		Check the printer's handshake protocol and serial port settings. The setting used must match the one being used by the host computer. See Serial Interface on page 46 for the printer's default serial port settings.
		The serial cable you are trying to use may not be a standard DTE or DCE type cable. See Serial Port Interface - Auto-detecting DTE and DCE on page 135
A label format was sent to the printer. Several labels print, then the printer skips, misplaces, misses, or distorts the image on the label.	The serial communication settings are incorrect.	Ensure that the flow control settings match the host system.
		Check the communication cable length.
		Check the printer driver or software communications settings (if applicable).
A label format was sent to the printer but was not recognized. The DATA light flashes but no printing occurs.	The prefix and delimiter characters set in the printer do not match the ones in the label format.	Verify the ZPL programmings prefix (COMMAND CHAR) and delimiter (DELIM./CHAR) characters. Configuration Setting to Command Cross-reference on page 146
	Incorrect data is being sent to the printer.	Check the communication settings on the computer. Ensure that they match the printer settings. If the problem continues, check the label format.

Miscellaneous Issues

Table 4 identifies miscellaneous issues with the printer, the possible causes, and the recommended solutions.

Table 4 • Miscellaneous Printer Problems

Problem	Possible Cause	Recommended Solution
Changes you made to parameter settings did not take effect or stay set.	Some parameters are set incorrectly.	1. Check the parameters and change or reset if necessary. 2. Cycle the printer OFF and then back ON.
	The ZPL ^J command was not used to save your configuration.	Refer to the ZPL Programming Guide or call a service technician.
	A firmware command turned off the ability to change the parameter.	
	A firmware command changed the parameter back to the previous setting.	
	If the problem persists, there may be a problem with the main logic board.	Call a service technician.
Non-continuous labels are being treated as continuous labels.	The printer was not calibrated for the media being used.	Set the printer for the correct media type (gap/notch, continuous, or mark) and calibrate the printer (Run a SmartCal Media Calibration on page 40), if necessary (see Manual Media Calibration on page 109).
	The printer is configured for continuous media.	
All indicator lights are on and the printer locks up. - or - The printer locks up while restarting	Internal electronic or firmware failure.	Call a service technician.
Ribbon Out warning, but a ribbon cartridge is installed	The Ribbon Cartridge Sensor Contact Pins or the Ribbon Cartridge's Smart Chip's contacts may be dirty or the chip may be damaged.	1. The cartridge's smart chip may be dirty, defective, or damaged. Inspect and clean the ribbon cartridge's Smart Chip's contacts with alcohol and a cleaning swab. Try a different cartridge if this does not work. 2. Clean the Ribbon Cartridge Sensor Contact Pins - see Sensor Cleaning on page 121 3. Call a service technician.
Ribbon Cartridge Authentication error, but a Genuine Zebra Ribbon Cartridge is installed and has not been refurbished or altered.		

Updating Printer Firmware

The printer's firmware may need to be updated periodically to get new features, improvements, and printer upgrades for media handling and communications.

Use Zebra Setup Utilities (ZSU) to load new firmware.

1. Open Zebra Setup Utilities.
2. Select your installed ZD420 printer.
3. Click on the 'Open Printer Tools' button and a 'Tools' window will open.
4. Click on the 'Action' tab.
5. Load the printer with media. See [Loading Roll Media on page 32](#).
6. Click on the text line - 'Send file'. The lower half of the window will present a filename and path with a Browse (...) button to select the latest firmware file you have downloaded from the Zebra Web site.
7. Observe the control panel and wait.
 If the firmware version on the USB Flash drive is different than the version installed on the printer, the firmware will download to the printer. The data indicator will flash green while the firmware is downloading. The printer will restart with all indicators flashing. When the firmware update has completed, the STATUS indicator () will display solid Green as the firmware is validated and installed. A printer Configuration Report is automatically printed and the firmware update has been completed.

USB Host

The USB host port allows you to connect a USB Flash drive to the printer to perform firmware updates.

Figure 1 • USB Host Port Location

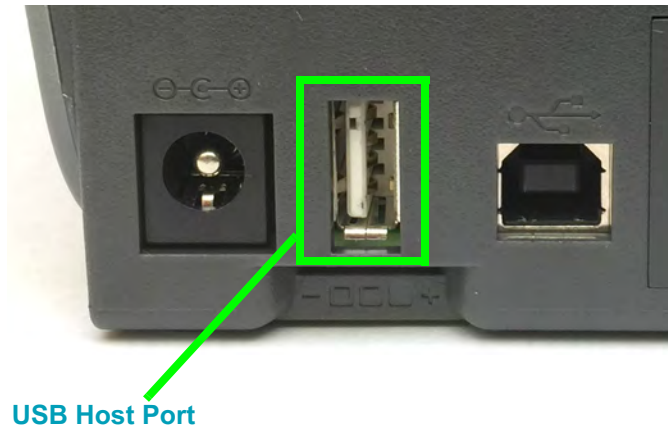

Important • The USB Flash drive must be formatted with the FAT file system. Filenames may be 1 to 16 alphanumeric characters (A, a, B, b, C, c, ..., 0, 1, 2, 3, ...) only. Do not use Asian characters, Cyrillic characters, or accented characters in file names.

Flash Drive Preparation and Firmware Update

1. On your USB Flash Drive, create the following:
 - a folder called Zebra
 - in that folder, create three sub-directories:
 - appl
 - commands
 - files

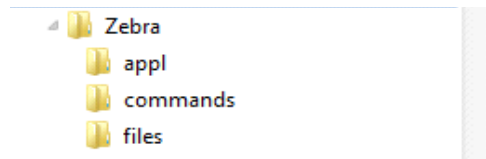

2. In the /appl folder, place a copy of the latest firmware for your printer.
3. Load the printer with media. See [Loading Roll Media on page 32](#).
4. Insert the USB Flash drive into the USB host port on your printer.
5. Observe the control panel and wait.

If the firmware version on the USB Flash drive is different than the version installed on the printer, the firmware will download to the printer. The data indicator will flash green while the firmware is downloading. The printer will restart with all indicators flashing. When the firmware update has completed, the STATUS indicator (◊) will display solid Green as the firmware is validated and installed. A printer Configuration Report is automatically printed and the firmware update has been completed.
6. Remove the USB Flash drive from the printer.

Ribbon Cartridge Programming Commands

The ZD420 printer has several Set Get Do (SGD) programming commands to support the use of the ribbon cartridge. See the ZPL Programmer's Guide for more details on SGD commands and SGD "ribbon" commands in particular. The following are examples of SGD ribbon cartridge commands.

```
! U1 getvar "device.feature.ribbon_cartridge"
! U1 getvar "ribbon.cartridge.part_number"
! U1 getvar "ribbon.cartridge.authenticated"
! U1 getvar "ribbon.cartridge.length_remaining"
! U1 getvar "ribbon.cartridge.serial_number"
! U1 getvar "ribbon.cartridge.width"
! U1 getvar "ribbon.cartridge.type"
! U1 getvar "ribbon.cartridge.length"
! U1 getvar "ribbon.cartridge.inserted"

ribbon.ribbon_low.warning : 50 , Choices: off,5,10,15,25,50,75,100
! U1 getvar "ribbon"
! U1 getvar "ribbon.ribbon_low.warning"
! U1 setvar "ribbon.ribbon_low.warning" "75"
! U1 setvar "ribbon.ribbon_low.warning" "off"
```

The Zebra Setup Utilities may be used to send commands and receive status back from the printer using the 'Open Communication With Printer' feature.

Operator Darkness Control

The Operator Darkness Control switch allows the operator to modify the darkness setting for minor variations in media and printers avoiding the need to change the program or driver settings sent to the printer.

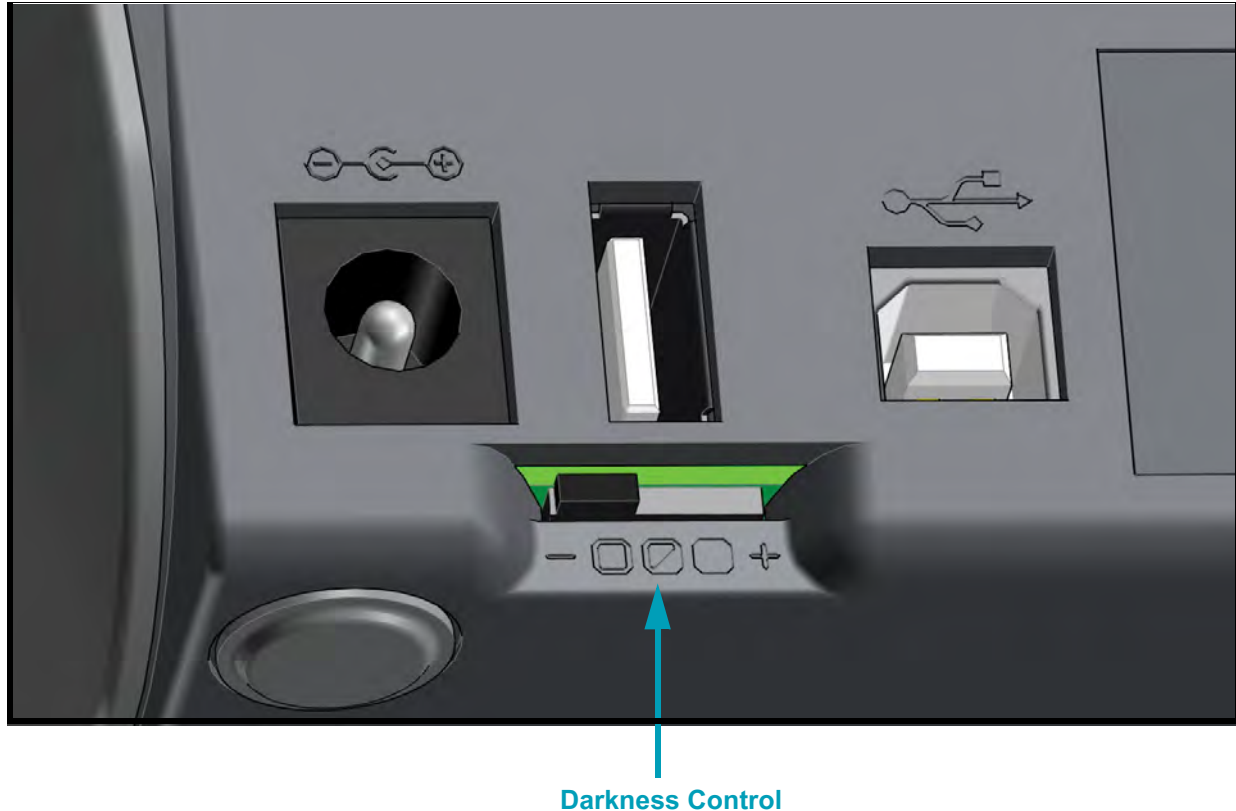

The control switch has three (3) settings:

- Left: no effect (Low - Default)
- Middle: increases darkness 3 levels (Medium)
- Right: increases darkness 6 levels (High).

The Low (default) setting makes no change to the actual Darkness setting as set by programming or driver setting. The Medium setting increases the Darkness level by 3, i.e. if the printer is set to the default darkness level of 20, then the actual darkness applied while printing will be 23. The High setting will add six (6) darkness levels to the set darkness level.



Important • Setting the Darkness too high or too low may reduce barcode readability.

Printer Diagnostics

Diagnostic reports, calibration procedures, restoring factory defaults and other diagnostics provide specific information about the condition of the printer.



Important • Use full-width media when performing self tests. If your media is not wide enough, the test labels may print on the platen (drive) roller. To prevent this from happening, check the print width, and ensure that the width is correct for the media that you are using.

Each self test is enabled by pressing a specific control panel key or combination of buttons while turning ON the printer power. Keep the button(s) pressed until the first indicator light turns off. The selected self test automatically starts at the end of the Power-On Self Test.



Note •

- When performing these self tests, do not send data to the printer from the host.
- If your media is shorter than the label to be printed, the test label continues on the next label.
- When canceling a self test prior to its actual completion, always reset the printer by turning it OFF and then ON.
- If the printer is in dispense mode and the liner is being taken up by the applicator, the operator must manually remove the labels as they become available.

Power-On Self Test

A Power-On Self Test (POST) is performed each time the printer power is turned ON. During this test, the control panel indicators turn on and off to ensure proper operation. At the end of this self test, only the STATUS indicator remains lit.

SmartCal Media Calibration

SmartCal is used to quickly calibrate the printer to the media currently loaded. During SmartCal, the printer will automatically determine the media sensing type (gap, black line or notch) and then measure the length of the media.

To activate Smart Calibration, complete these steps:

1. Make sure media is properly loaded, the printer cover is closed, and printer power is ON.
2. Press and hold **PAUSE + CANCEL** buttons for two seconds.
3. The printer will feed and measure several labels. When done, the printer will return to **READY** status.

If the printer should fail to recognize and correctly calibrate to the media, please refer to the [Manual Media Calibration](#) procedure later in this section.

Configuration Report (CANCEL Self Test)

The Configuration Report diagnostic prints a set of printer and network configuration reports.

To print the configuration report, complete these steps:

1. Make sure media is properly loaded, the printer cover is closed, and printer power is ON.
2. If printer power is OFF, press and hold **CANCEL** button while setting the printer power to ON. Hold **CANCEL** button down until the STATUS indicator is the only indicator lit.
 - or -
 If printer power is ON, press **FEED + CANCEL** for two seconds.
3. The Printer and Network Configuration Reports (below) will be printed and the printer will return to READY status.

Sample Printer Configuration

PRINTER CONFIGURATION	
Zebra Technologies ZTC ZD420-203dpi ZPL 50J154800145	
+10.0.....	DARKNESS
HIGH.....	DARKNESS SWITCH
6.0 IPS.....	PRINT SPEED
+000.....	TEAR OFF
TEAR OFF.....	PRINT MODE
GAP/NOTCH.....	MEDIA TYPE
TRANSMISSIVE.....	SENSOR SELECT
THERMAL-TRANS.....	PRINT METHOD
832.....	PRINT WIDTH
1224.....	LABEL LENGTH
39.0IN 998MM.....	MAXIMUM LENGTH
MAINT. OFF.....	EARLY WARNING
NOT CONNECTED.....	USB COMM.
AUTO.....	SER COMM. MODE
9600.....	BAUD
8 BITS.....	DATA BITS
NONE.....	PARITY
XON/XOFF.....	HOST HANDSHAKE
NONE.....	PROTOCOL
NORMAL MODE.....	COMMUNICATIONS
<^> ZEH.....	CONTROL PREFIX
<^> SEH.....	FORMAT PREFIX
<.> ZCH.....	DELIMITER CHAR
ZPL II.....	ZPL MODE
INACTIVE.....	COMMAND OVERRIDE
NO MOTION.....	MEDIA POWER UP
FEED.....	HEAD CLOSE
DEFAULT.....	BACKFEED
+000.....	LABEL TOP
+0000.....	LEFT POSITION
10.....	RIBBON LOW MODE
DISABLED.....	REPRINT MODE
041.....	WEB SENSOR
096.....	MEDIA SENSOR
075.....	RIBBON SENSOR
128.....	TAKE LABEL
069.....	MARK SENSOR
044.....	MARK MED SENSOR
048.....	TRANS GAIN
028.....	TRANS LED
040.....	RIBBON GAIN
076.....	MARK GAIN
070.....	MARK LED
DPCSWFXM.....	MODES ENABLED
.....	MODES DISABLED
832 8/MM FULL.....	RESOLUTION
3.2.....	LINK-OS VERSION
V77.19.152P31840 <.....	FIRMWARE
1.3.....	XML SCHEMA
6.5.0 0.517.....	HARDWARE ID
8192k.....R:	RAM
65536k.....E:	ONBOARD FLASH
NONE.....	FORMAT CONVERT
ENABLED.....	IDLE DISPLAY
01/08/16.....	RTC DATE
19:43.....	RTC TIME
DISABLED.....	ZBI
2.1.....	ZBI VERSION
READY.....	ZBI STATUS
28 LABELS.....	NONRESET CNTR
28 LABELS.....	RESET CNTR1
28 LABELS.....	RESET CNTR2
137 IN.....	NONRESET CNTR
137 IN.....	RESET CNTR1
137 IN.....	RESET CNTR2
347 CM.....	NONRESET CNTR
347 CM.....	RESET CNTR1
347 CM.....	RESET CNTR2
EMPTY.....	SLOT 1
0.....	MASS STORAGE COUNT
0.....	HID COUNT
OFF.....	USB HOST LOCK OUT
FIRMWARE IN THIS PRINTER IS COPYRIGHTED	

Sample Network Configuration Bluetooth LE only

Network Configuration	
Zebra Technologies ZTC ZD420-203dpi ZPL 50J154800145	
Bluetooth	
1.4.0.0.....	FIRMWARE
02/02/2015.....	DATE
on.....	DISCOVERABLE
4.0.....	RADIO VERSION
on.....	ENABLED
7C:EC:79:33:C2:01.....	MAC ADDRESS
50J154800145.....	FRIENDLY NAME
no.....	CONNECTED
.....	MIN SECURITY MODE
.....	CONN SECURITY MODE
not supported.....	iOS
FIRMWARE IN THIS PRINTER IS COPYRIGHTED	

Printer Network Configuration Report

ZD420 printers with the Ethernet (LAN and WLAN) Print Server option print an additional printer configuration report section for information needed to establish and trouble shoot Ethernet (LAN and WLAN) network printing. The following printout is printed with the ZPL `~WL` command.

```

Network Configuration
Zebra Technologies
ZTC ZD420-300dpi ZPL
50J154800150

Wired..... PRIMARY NETWORK
PrintServer..... LOAD LAN FROM?
WIRELESS..... ACTIVE PRINTSRVR

Wireless*
ALL..... IP PROTOCOL
172.029.016.039... IP ADDRESS
255.255.255.000... SUBNET
172.029.016.001... GATEWAY
172.029.001.003... WINS SERVER IP
YES..... TIMEOUT CHECKING
300..... TIMEOUT VALUE
000..... ARP INTERVAL
9100..... BASE RAW PORT
9200..... JSON CONFIG PORT
INSERTED..... CARD INSERTED
02dfH..... CARD MFG ID
9134H..... CARD PRODUCT ID
ac:3f:a4:74:82:c4.. MAC ADDRESS
YES..... DRIVER INSTALLED
INFRASTRUCTURE... OPERATING MODE
125..... ESSID
1.0..... CURRENT TX RATE
OPEN..... WEP TYPE
NONE..... WLAN SECURITY
1..... WEP INDEX
000..... POOR SIGNAL
LONG..... PREAMBLE
YES..... ASSOCIATED
ON..... PULSE ENABLED
15..... PULSE RATE
OFF..... INTL MODE
USA/CANADA..... REGION CODE
USA/CANADA..... COUNTRY CODE
0x3FFFFFFF..... CHANNEL MASK

Bluetooth
4.3.ip1..... FIRMWARE
02/13/2015..... DATE
on..... DISCOVERABLE
3.0/4.0..... RADIO VERSION
on..... ENABLED
AC:3F:A4:74:82:C5.. MAC ADDRESS
50J154800150..... FRIENDLY NAME
no..... CONNECTED
1..... MIN SECURITY MODE
nc..... CONN SECURITY MODE
supported..... IOS

FIRMWARE IN THIS PRINTER IS COPYRIGHTED
  
```

The regular printout of the configuration status label has some of the printer’s network settings such as IP Address, on the lower half of the printout.

The printer’s IP address is needed to identify and configure the printer for operations on your network. See the Internal Wired and Wireless Print Server manual for more information.

Printer Bluetooth Configuration Report

ZD420 printers always print an additional printer configuration report for information needed to establish and trouble shoot Bluetooth printing. All ZD420 printers have Bluetooth LE and as a factory option Bluetooth Classic. The following printout is printed with the ZPL `~WL` command.

```

Network Configuration
-----
Zebra Technologies
ZTC ZD420-300dpi ZPL
50J154800150
-----
Wired..... PRIMARY NETWORK
PrintServer..... LOAD LAN FROM?
WIRELESS..... ACTIVE PRINTSRVR
-----
Wireless*
ALL..... IP PROTOCOL
172.029.016.039.... IP ADDRESS
255.255.255.000.... SUBNET
172.029.016.001.... GATEWAY
172.029.001.003.... WINS SERVER IP
YES..... TIMEOUT CHECKING
300..... TIMEOUT VALUE
000..... ARP INTERVAL
9100..... BASE RAW PORT
9200..... JSON CONFIG PORT
INSERTED..... CARD INSERTED
02dfH..... CARD MFG ID
9134H..... CARD PRODUCT ID
ac:3f:a4:74:82:c4.. MAC ADDRESS
YES..... DRIVER INSTALLED
INFRASTRUCTURE.... OPERATING MODE
125..... ESSID
1.0..... CURRENT TX RATE
OPEN..... WEP TYPE
NONE..... WLAN SECURITY
1..... WEP INDEX
000..... POOR SIGNAL
LONG..... PREAMBLE
YES..... ASSOCIATED
ON..... PULSE ENABLED
15..... PULSE RATE
OFF..... INTL MODE
USA/CANADA..... REGION CODE
USA/CANADA..... COUNTRY CODE
0x3FFFFFFF..... CHANNEL MASK
-----
Bluetooth
4.3.ip1..... FIRMWARE
02/13/2015..... DATE
on..... DISCOVERABLE
3.0/4.0..... RADIO VERSION
on..... ENABLED
AC:3F:A4:74:82:C5.. MAC ADDRESS
50J154800150..... FRIENDLY NAME
no..... CONNECTED
1..... MIN SECURITY MODE
nc..... CONN SECURITY MODE
supported..... iOS
-----
FIRMWARE IN THIS PRINTER IS COPYRIGHTED
  
```

iOS Support
 Setting

The printer’s IP address is needed to identify and configure the printer for operations on your network. See the Bluetooth Wireless Guide for more information.

iOS Bluetooth Support

- iOS devices have Bluetooth Classic 4.X (with 3.0 compatibility) when the Wi-Fi and Bluetooth Classic wireless connectivity option is installed in your printer and is noted as ‘supported’ on the bottom of the Bluetooth Configuration report.
- All ZD400 series printers supports Bluetooth Low Energy. The iOS setting is noted on the bottom of the Bluetooth Configuration report as ‘not supported’ when the wireless connectivity option is not installed.

Print Quality Report (FEED self test)

Different types of media may require different darkness settings. This section contains a simple but effective method for determining the ideal darkness for printing barcodes that are within specifications.

During the Print Quality Report (FEED self test), a series of labels are printed at different darkness settings at two different print speeds. The relative darkness and the print speed are printed on each label. The barcodes on these labels may be ANSI-graded to check print quality.

During this test, one set of labels is printed at low speed, and another set is printed at the high speed. The darkness value starts at three settings lower than the printer's current darkness value (relative darkness of -3) and increase until the darkness is three settings higher than the current darkness value (relative darkness of +3).

The speed at which labels are printed during this print quality test depends on the dot density of the printhead.

- 300 dpi printers: prints 7 labels at 51mm/sec (2 ips) and 102 mm/sec (4 ips) print speeds.
- 203 dpi printers: prints 7 labels at 51mm/sec (2 ips) and 152 mm/sec (6 ips) print speeds.

To perform a Print Quality Report, complete these steps:

1. Print a configuration report to show the printer's current settings. Press and hold the **FEED** and **CANCEL** buttons for two (2) seconds to print the report.
2. Turn OFF the printer.
3. Press and hold **FEED** while setting the printer power to ON. Hold **FEED** until the Status indicator is the only indicator lit.

The printer prints a series of labels (Figure 2) at various speeds and darkness settings higher and lower than the darkness value shown on the configuration label.

Figure 2 • Print Quality Report



- See [Figure 3](#) and [Table 5](#). Inspect the test labels and determine which one has the best print quality for your application. If you have a barcode verifier, use it to measure bars/spaces and calculate the print contrast. If you do not have a barcode verifier, use your eyes or the system scanner to choose the optimal darkness setting based on the labels printed in this self test.

Figure 3 • Barcode Darkness Comparison

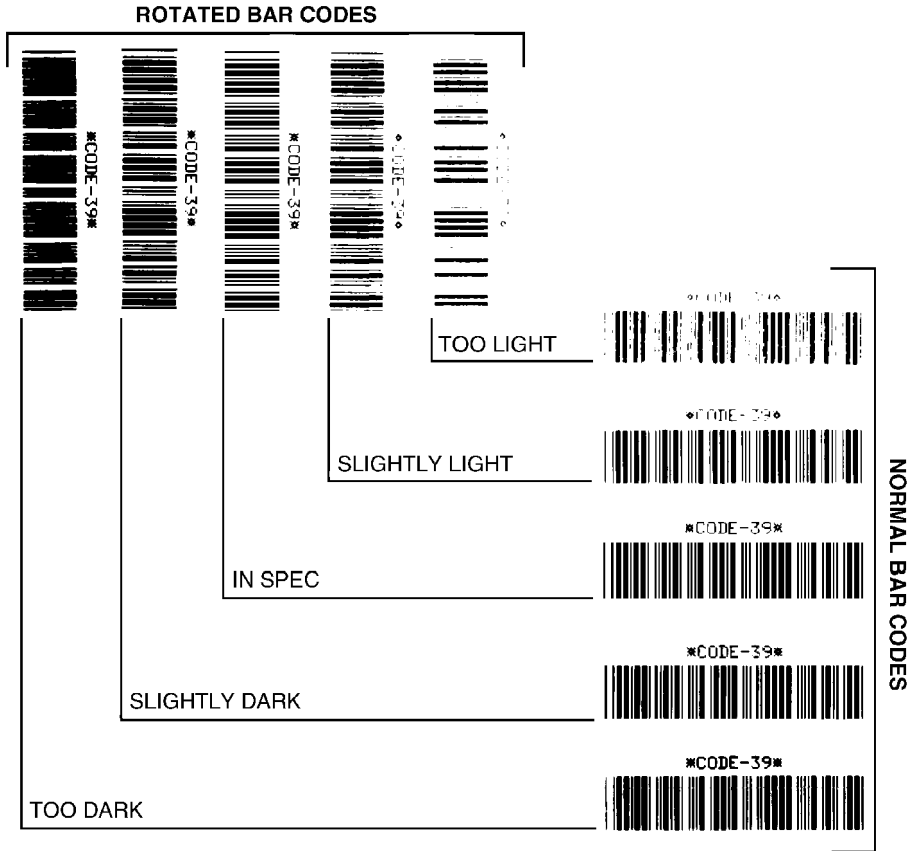

Table 5 • Judging Barcode Quality

Print Quality	Description
Too dark	<p>Labels that are too dark are fairly obvious. They may be readable but not “in-spec.”</p> <ul style="list-style-type: none"> • The normal barcode bars increase in size. • The openings in small alphanumeric characters may appear filled in. • Rotated barcode have bars and spaces run together.
Slightly dark	<p>Slightly dark labels are not as obvious.</p> <ul style="list-style-type: none"> • The normal barcode will be “in-spec.” • Small character alpha numerics will be bold and could be slightly filled in. • The rotated barcode spaces are small when compared to the “in-spec” code, possibly making the code unreadable.
“In-spec”	<p>The “in-spec” barcode can only be confirmed by a verifier, but it should exhibit the following visible characteristics.</p> <ul style="list-style-type: none"> • The normal barcode will have complete, even bars and clear, distinct spaces. • The rotated barcode will have complete, even bars and clear, distinct spaces. Although it may not look as good as a slightly dark barcode, the barcode will be “in-spec.” • In both normal and rotated styles, small alphanumeric characters look complete.
Slightly light	<p>Slightly light labels are, in some cases, preferred to slightly dark ones for “in-spec” barcodes.</p> <ul style="list-style-type: none"> • Both normal and rotated barcodes will be in spec, but small alphanumeric characters may not be complete.
Too light	<p>Labels that are too light are obvious.</p> <ul style="list-style-type: none"> • Both normal and rotated barcodes have incomplete bars and spaces. • Small alphanumeric characters are unreadable.

5. Note the relative darkness value and the print speed printed on the best test label.
6. Add or subtract the relative darkness value from the darkness value specified on the configuration label. The resulting numeric value is the best darkness value for that specific label/ribbon combination and print speed.
7. If necessary, change the current darkness value to the darkness value on the best test label.
8. If necessary, change the current print speed to the speed value on the best test label.

Reset Printer Factory Defaults (PAUSE + FEED Self Test)

This resets the printer configuration to the factory default values for the non-network printer settings. Perform a sensor calibration after this procedure. (See [Manual Media Calibration on page 109.](#))

To perform a **Reset Printer Factory Defaults procedure, complete these steps:**

1. Turn OFF the printer.
2. Press and hold **PAUSE + FEED** while turning ON the printer.
3. Hold **PAUSE + FEED** until the STATUS indicator () is the only indicator lit.

The printer configuration is reset to the factory default values. No labels print at the end of this action.



Note • The printer has a reset button under the printer, See [Reset Button on page 105](#)

Reset Network Factory Defaults (PAUSE + CANCEL Self Test)

This procedure resets the network configuration settings only to the factory default values.

To perform a **Reset Network Factory Defaults procedure, complete these steps:**

1. Turn OFF the printer.
2. Press and hold **PAUSE + CANCEL** while turning ON the printer.
3. Hold **PAUSE + CANCEL** until the STATUS indicator () is the only indicator lit.

The printer's network configuration is reset to the factory default values. No labels print at the end of this action.

Reset Button

In addition to the power on configurations described previously, the ZD420 has a dedicated reset button located on the bottom of the printer which can be pressed with a paperclip or similar small object.

Pressing the button has the following results based on the length of the button press:

0-1 second	No action
1-5 seconds	Printer reset – Printer performs a factory reset and will automatically print a configuration label (and network label if present)
6-10 seconds	Network reset – Printer drops connection to the network, and a network factory default reset occurs. Upon completion of the reset, a configuration and network configuration label are automatically printed.
More than 10 seconds	Exits the factory defaults function without resetting the printer or making changes



Communication Diagnostics Test

The communication diagnostics test is a troubleshooting tool for checking the connection between the printer and the host computer. When the printer is in diagnostics mode, it prints all data received from the host computer as straight ASCII characters with the hex values below the ASCII text. The printer prints all characters received, including control codes such as CR (carriage return). [Figure 4](#) shows a typical test label from this test.



Note • The test label prints upside-down.

Figure 4 • Communications Diagnostics Test Label

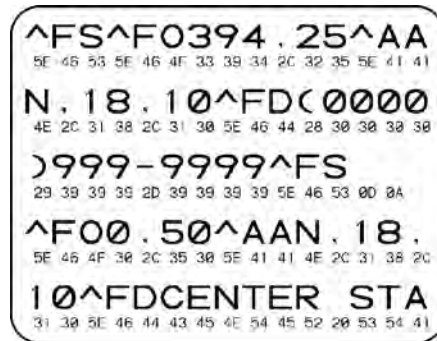

To use communications diagnostics mode, complete these steps:

1. Ensure media is loaded and printer power is ON.
2. Set the print width equal to or less than the label width being used for the test.
3. Press and hold **Pause + Feed** for two seconds. When active, the STATUS indicator (◊) will alternate between green and yellow.

The printer enters diagnostics mode and prints any data received from the host computer on a test label

4. Check the test label for error codes. For any errors, check that your communication parameters are correct.

Errors show on the test label as follows:

- **FE** indicates a framing error.
- **OE** indicates an overrun error.
- **PE** indicates a parity error.
- **NE** indicates noise.

5. Press and hold **Pause + Feed** for two seconds or turn the printer power off (O) and then back ON to exit this self test and return to normal operation.

Sensor Profile

Use the sensor profile image (which will extend across several labels or tags) to troubleshoot the following situations:

- The printer experiences difficulty in determining gaps (web) between labels.
- The printer incorrectly identifies preprinted areas on a label as gaps (web).
- The printer cannot detect ribbon.

With the printer in the Ready state, print a sensor profile in one of these ways:

Using the buttons on the control panel	<ol style="list-style-type: none"> Turn OFF the printer. Press and hold FEED + CANCEL while turning ON the printer. Hold FEED + CANCEL until the STATUS indicator () is the only indicator lit.
Using ZPL	<ol style="list-style-type: none"> Send the <code>~JG</code> command to the printer. See the Zebra Programming Guide for more information about this command.

Compare your results to the examples shown earlier in this section. If the sensitivity of the sensors must be adjusted, calibrate the printer (see [Manual Media Calibration on page 109](#)).

Media Sensor Profile (Figures 5 and 6) The line labeled MEDIA (1) on the sensor profile indicates the media sensor readings. The media sensor threshold settings is indicated by WEB (2). The media out threshold is indicated by OUT (3). The upward spikes (4) indicate gaps between labels (the web), the lines between the spikes (5) indicate where labels are located, and the numbered line at the top (6) provides measurement in dots from the start of the printout.

If you compare the sensor profile printout to a length of your media, the spikes should be the same distance apart as the gaps on the media. If the distances are not the same, the printer may be having difficulty determining where the gaps are located.

Figure 5 • Sensor Profile (Gap Media)

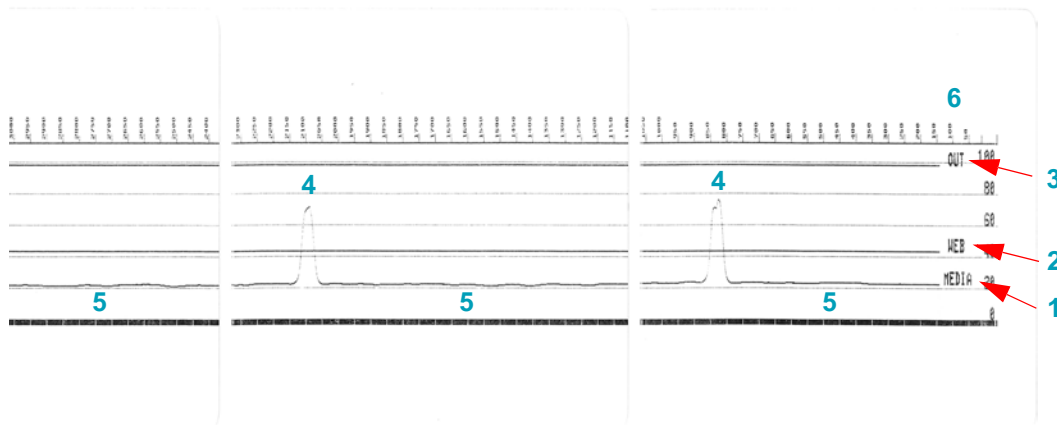
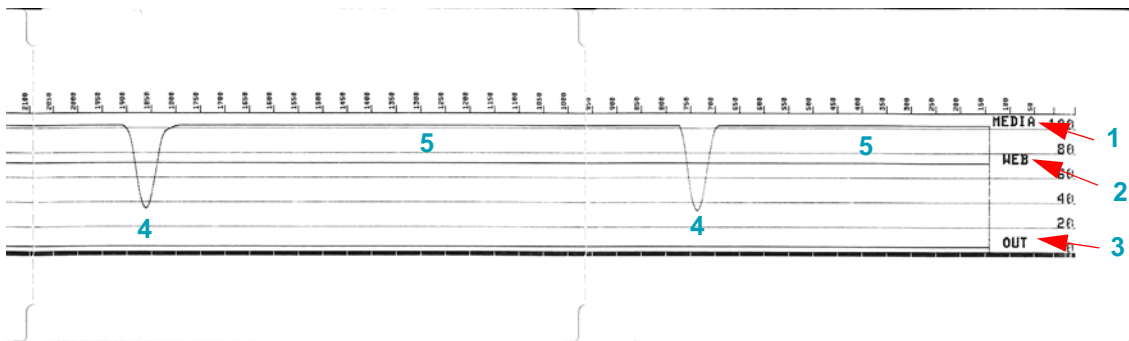



Figure 6 • Sensor Profile (Black Mark Tag Media)



Advanced Mode





Advanced Mode is used to access several manual adjustment modes in the printer. Each manual adjustment mode is described in detail in the following sections.

To activate Advanced Mode, complete these steps:

1. Ensure media is loaded and printer power is ON.
2. Press **PAUSE** for two seconds, all indicators will flash yellow.
3. The STATUS indicator () will show solid yellow, indicating the currently selected mode is: Manual Media Calibration.
4. Pressing **FEED** will sequentially cycle through all available modes.
5. Pressing **PAUSE** will activate the selected mode.
6. Pressing **CANCEL** will exit Advanced Mode.



Manual Media Calibration

While in Advanced Mode, pressing **PAUSE** while the Status indicator () is illuminated yellow will start Manual Media Calibration.

1. The MEDIA indicator () will flash yellow then the Pause indicator () will flash. Open the printer and verify the media sensor is in the center position for label gap (transmissive) sensing. Remove 3 inches or 80mm of labels from the liner. Place the label-less area of the liner over the platen (drive) roller with the leading edge of the first label under the media guides.
2. Close the printer and press **PAUSE** once. The MEDIA indicator () will flash as the media liner is measured. When complete, the Pause indicator () will begin flashing.
3. Open the printer and reposition the media so that a label is located directly above the movable sensor. Close the printer.
4. Press **PAUSE** once. The printer will feed and measure several labels. If the printer is able to determine the correct media type (gap, black mark or notch) and measure the media length, the printer will return to the READY state.

This advanced mode is typically used to calibrate the printer to media that is not correctly recognized during Smart Calibration. If your media uses black mark or notch sensing, ensure the media sensor is in to the proper location to “see” the mark or notch. If your media is pre-printed, either on the front of the label or on the back of the liner, position the sensor so that it is in a position with minimal printing. You may need to perform Manual Media Calibration several times, moving the media sensor, until the printer completes the calibration process and returns to the READY state.

Manual Print Width Adjustment

While in Advanced Mode, pressing MEDIA indicator () while the Pause indicator () is illuminated yellow will start Manual Print Width Adjustment while in Advanced mode, see [Advanced Mode on page 109](#). The printer will print a 16mm (0.63 inch) box and pause momentarily. The printer will then print a slightly larger box and again pause. When you see the printer print a box that matches the width of your media, press **FEED** to set the print width and return to READY state.

To return to the maximum print width setting, allow the printer to proceed without pressing the **FEED** button.

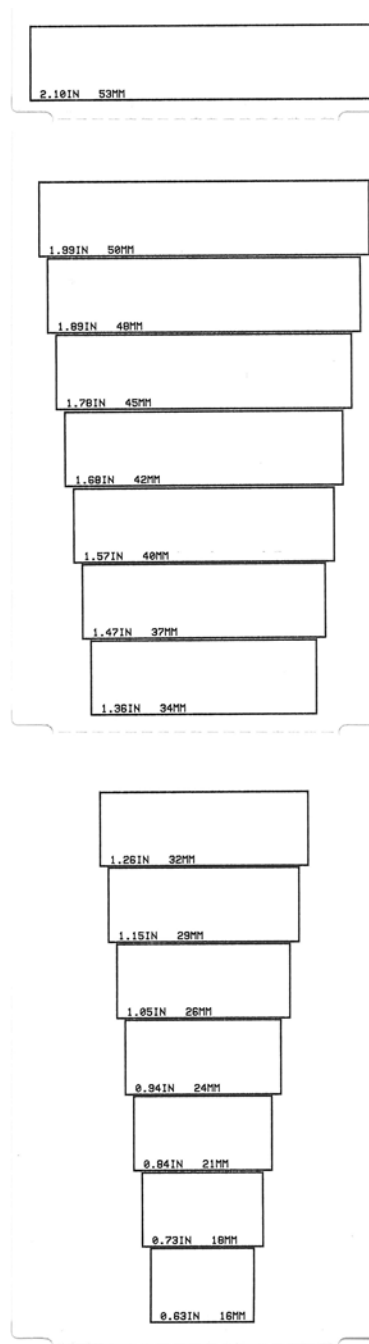

Manual Print Darkness Adjustment

Pressing **PAUSE** while the DATA indicator () is illuminated yellow will start Manual Print Darkness Adjustment. The printer will print a test pattern showing the current darkness number and several barcode patterns and then pause momentarily. The printer will then repeat the pattern with the next darkness level. When you see the printer print a pattern with solid even black lines, press **FEED** to set the darkness value and return to the READY state.

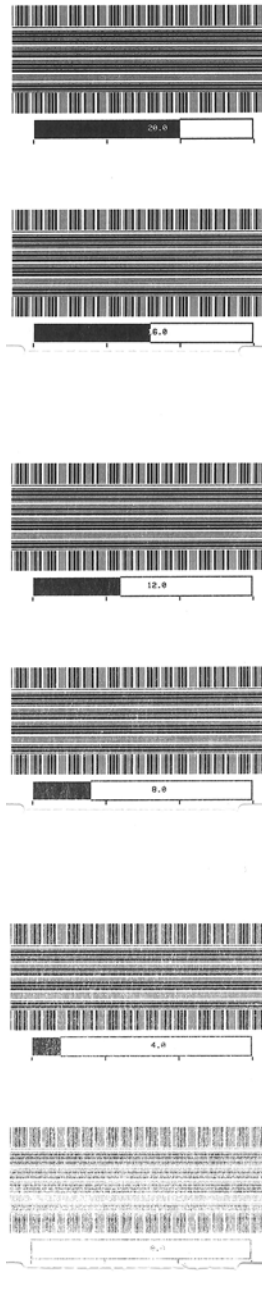

Factory Test Modes

The printer includes print modes that are intended for factory test only.

Test mode 1 is initiated by holding **PAUSE** while turning ON printer power. When activated, the printer will begin printing various test patterns used to evaluate printer performance.

Test mode 2 is initiated by holding **PAUSE + FEED + CANCEL** for two seconds while printer power is ON. When activated, the printer will begin printing various test patterns used to evaluate printer performance.



Note • Both of these test modes will consume a considerable amount of media as the tests are performed.

You can exit either of these test modes by pressing and holding **POWER** until the printer power is switched OFF.

Maintenance

This section provides routine cleaning and maintenance procedures.

Cleaning

When you clean the printer, use one of the following supplies that best suits your needs:

Cleaning Supplies	Order Quantity	Intended Purpose
Cleaning pens (105950-035)	Set of 12	Clean printhead
Cleaning swabs (105909-057)	Set of 25	Clean media path, guides and sensors

You can find access to cleaning supplies at <http://www.zebra.com/supplies>.

The cleaning process takes just a couple of minutes using the steps outlined below.

Printer Part	Method	Interval
Printhead	Let the printhead to cool for a minute, then use a new cleaning pen to swab the dark line on the printhead cleaning from the center to the outside edges of the printhead. See Cleaning the Printhead on page 115	Clean the printhead after every 5 rolls printed
Platen roller	Before cleaning, remove the platen roller by releasing both the left and right platen bearings. Clean the roller thoroughly with 99% medical-grade alcohol and a cleaning swab or lint-free cloth. See Platen Cleaning and Replacement on page 124	As needed.
Peel bar	Clean it thoroughly with 99% medical-grade alcohol and a fiber-free cleaning swab. Let alcohol evaporate completely.	
Media path		
Cutter Option	The cutter blade mechanism does not require maintenance cleaning. DO NOT clean the blade or mechanism with solvents or WD-40. This blade has a special coating to resist adhesives and wear.	
Exterior	Water-dampened cloth. See the 'Guide To Disinfecting and Cleaning Zebra® Healthcare Printers' on the Zebra Web site for the latest information on tested and approved cleaning materials, and cleaning methods.	As needed. Healthcare printers - cleaning frequency is set by medical policies and practices of your institution or governing agencies.
Interior	Gently brush out printer.	



Caution • Adhesives and small pieces of media can over time transfer onto the printer components along the media path including the platen and printhead. This build-up can accumulate dust and debris. Failure to clean the printhead, media path and platen roller could result in inadvertent loss of labels, label jams and possible damage to the printer.



Important • Using too much alcohol can result in contamination of the electronic components requiring a much longer drying time before the printer will function properly.

Cleaning the Printhead

Always use a new cleaning pen on the printhead (an old pen carries contaminants from its previous use that may damage the printhead).



Caution • The printhead becomes hot while printing. To protect from damaging the printhead and risk of personal injury, avoid touching the printhead. Use only the cleaning pen to perform maintenance.

When you load new media, you can also clean the printhead.

1. Pull the two (2) Release Arms out to release the Ribbon Drive Transport. The arms are located on the left and right sides of the printer. The Ribbon Drive Transport and Printhead Actuator Arm will now be loose.

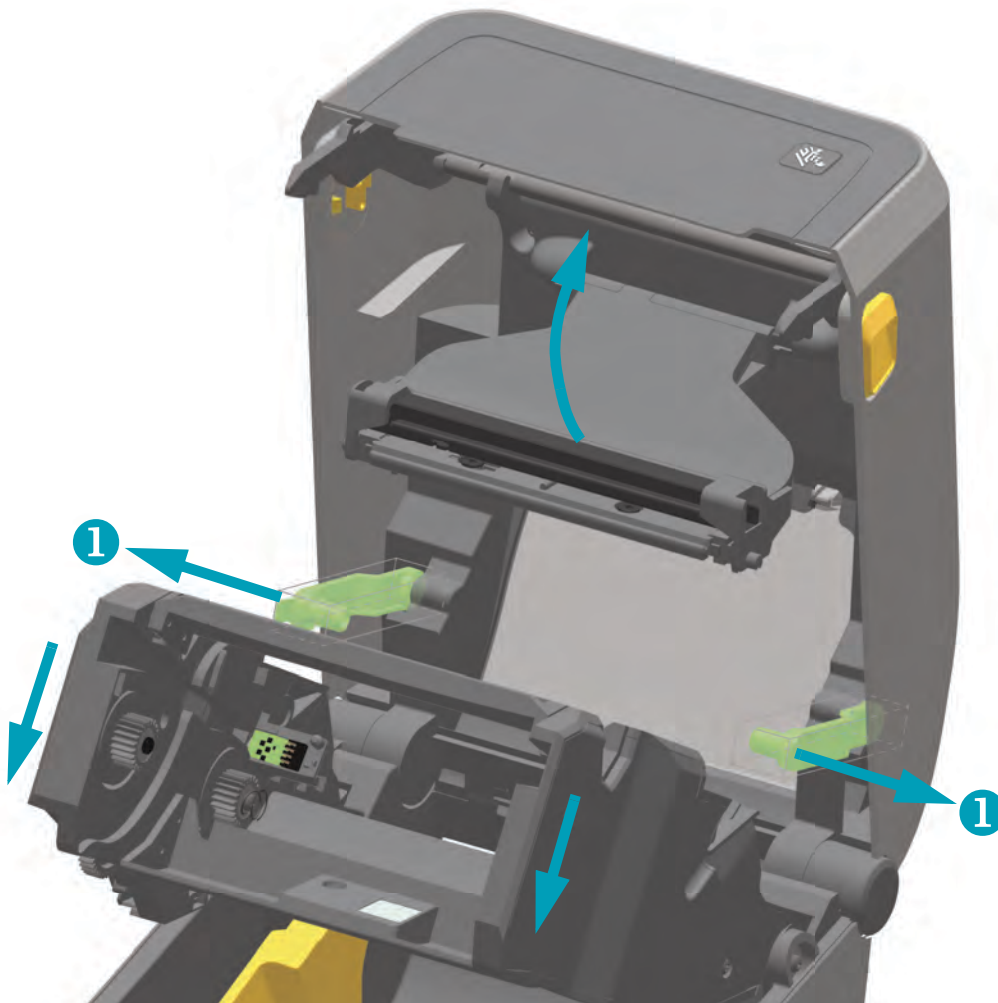

2. Swing the Printhead Actuator Arm up until it touches the printer's top cover. Hold the Printhead Actuator Arm in this position for access to the printhead.

3. Rub the cleaning pen across the dark area of the printhead. Clean from the middle to the outside. This will move adhesive transferred from the outer edges of media to the area outside of media path.
4. Wait one minute before closing the printer.

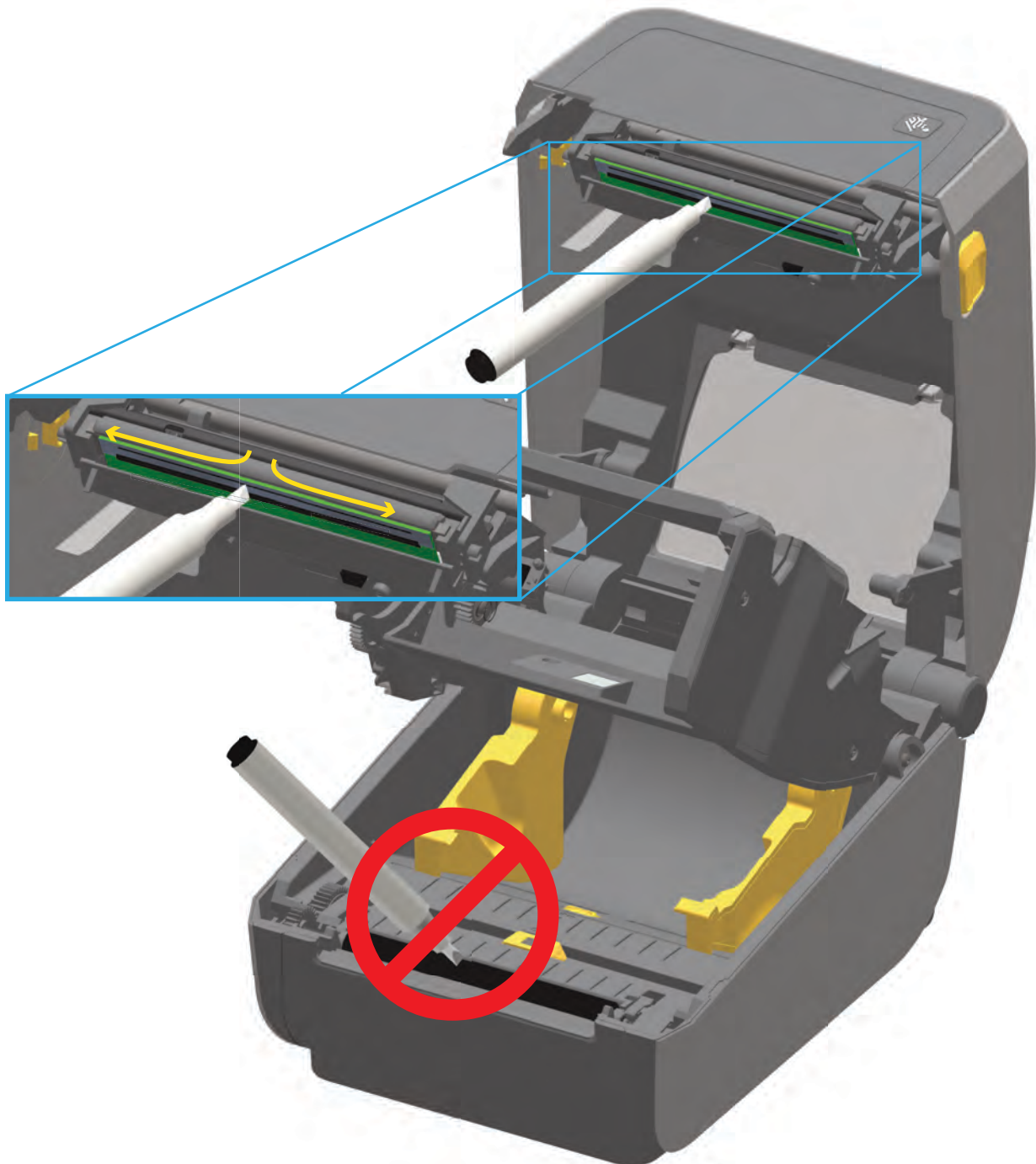

5. Release the Printhead Actuator Arm and then push the Ribbon Drive Transport into the Printhead Actuator Arm. The Release Arms will snap into place relinking the Ribbon Drive Transport to the top cover and the Printhead Actuator Arm.

Media Path Cleaning

Use a cleaning swab and/or a lint free cloth to remove debris, dust or crust that has built-up on the holders, guides and media path surfaces. Lightly moisten the swab or cloth with 99% solution medical-grade alcohol. For hard to clean areas, use extra alcohol on a cleaning swab to soak the debris to break up any adhesive that may have accumulated on surfaces in the media compartment.

Do not clean the printhead, movable sensor, or platen as part of this process.

1. Pull the two (2) Release Arms out to release the Ribbon Drive Transport. The arms are located on the left and right sides of the printer. The Ribbon Drive Transport and Printhead Actuator Arm will now be loose.

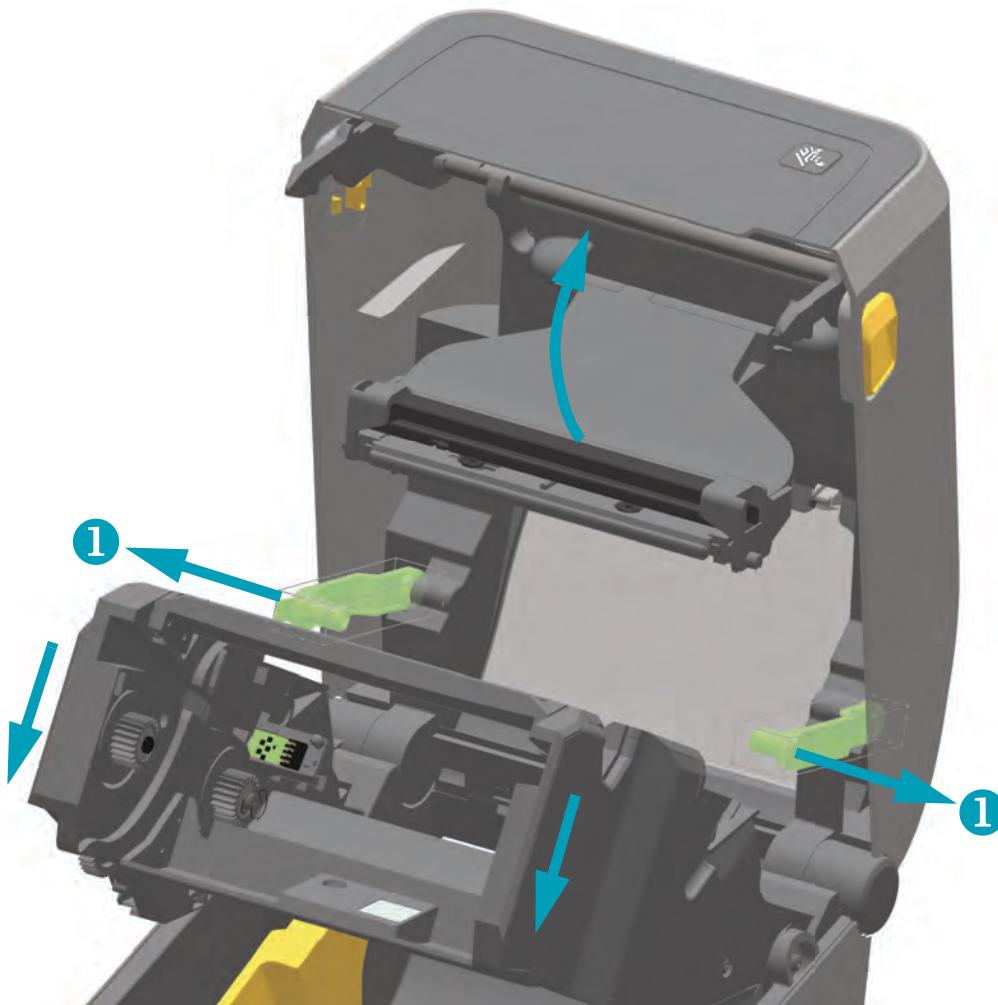

2. Swing the Printhead Actuator Arm up until it touches the printer's top cover. Hold the Printhead Actuator Arm in this position for access to the area below the printhead, see the next graphic.

3. Wipe the areas (outlined in blue) below the Printhead Actuator Arm and the Ribbon Drive Transport.

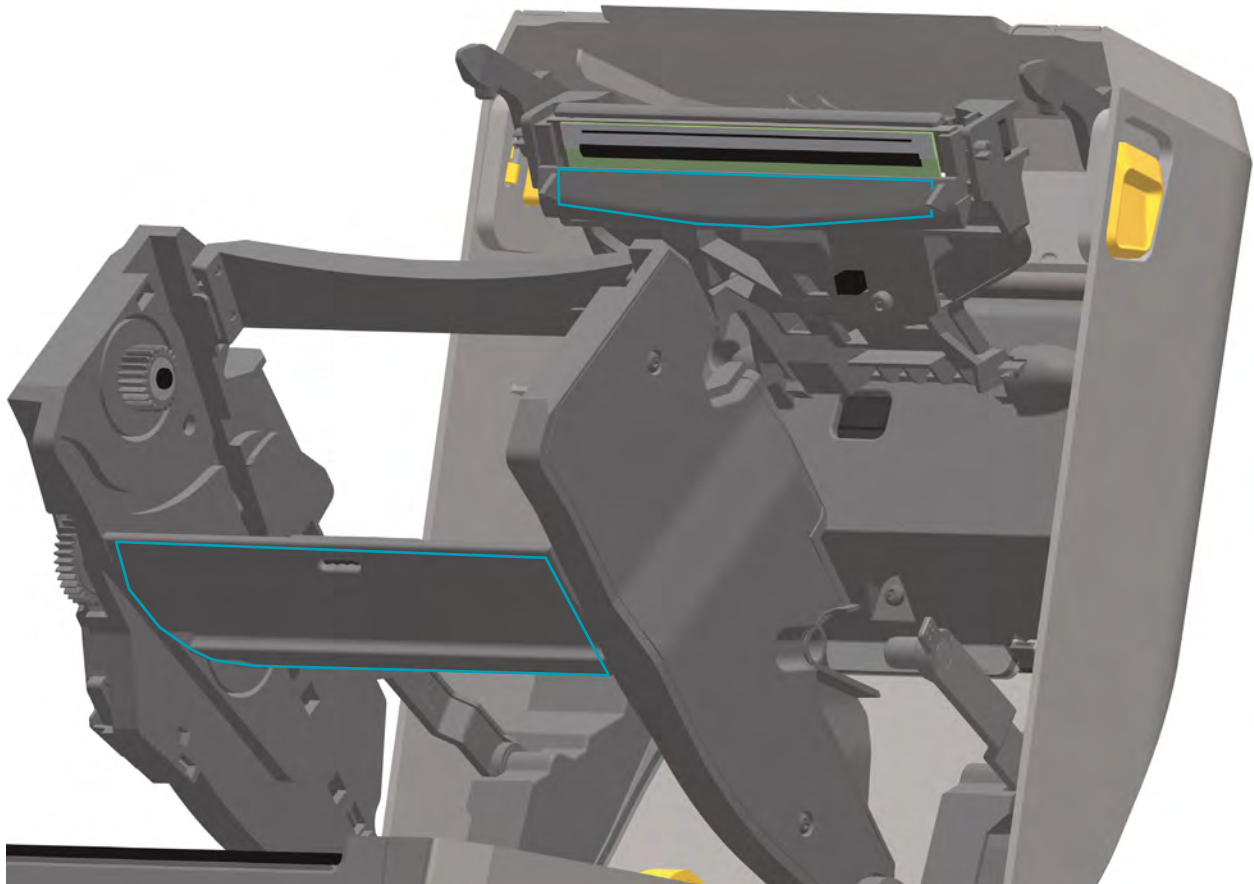

4. Wipe the inside surfaces of the roll holders and the underside of the media guides with a swab.
5. Wipe the movable sensor slide channel (but not sensor). Move the sensor to get to all areas.
6. Wait one minute before closing the printer. Discard the cleaning swab after use.

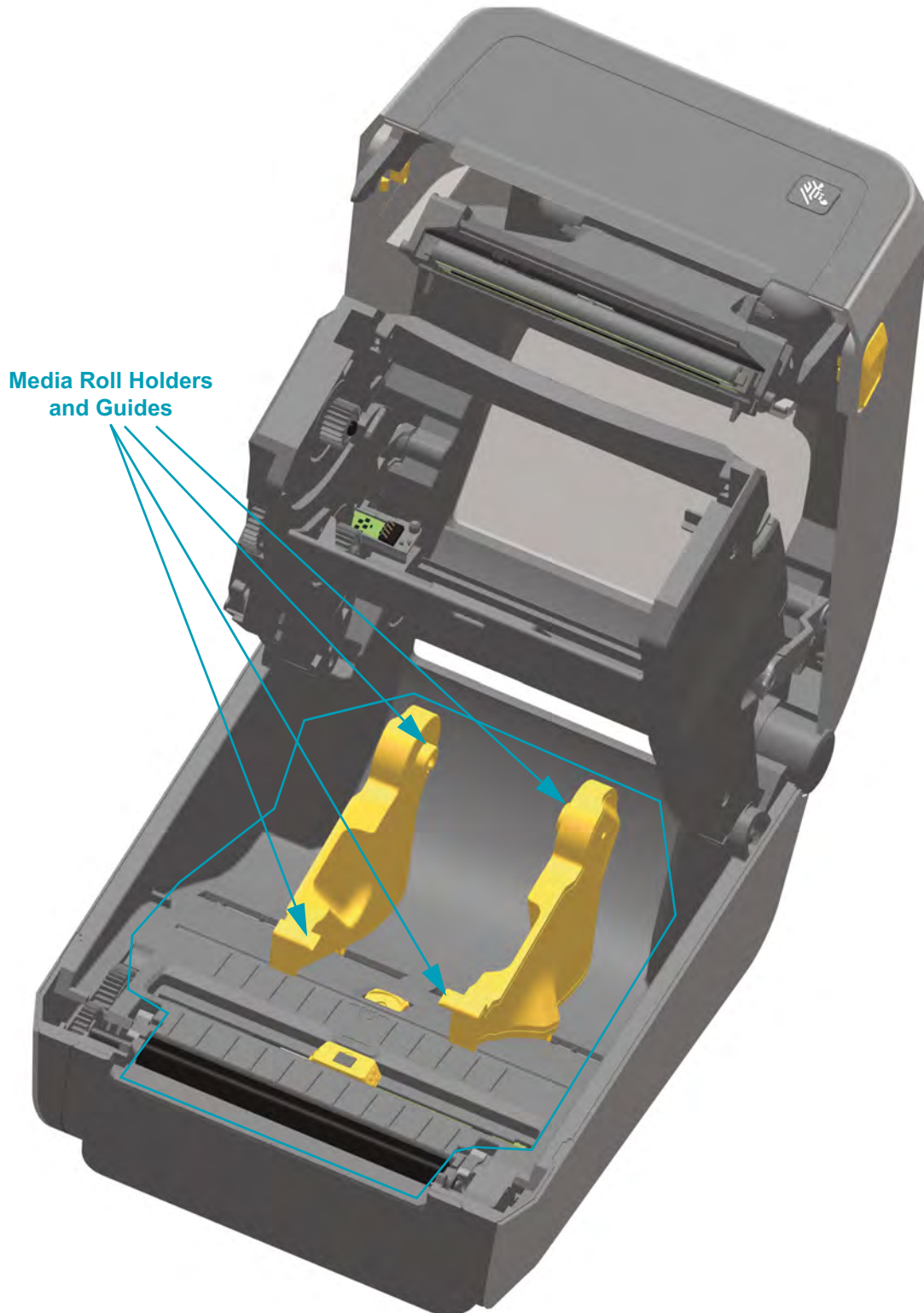

Cleaning the Cutter and Label Dispenser Options

This is a continuation of cleaning the media path for either option if it is installed on your printer.

Cutter

The media path surfaces can be cleaned but not the internal cutter blades or mechanism.

1. Wipe the ridges and the plastic surfaces of the media entry (inside) and exit slot (outside) of the cutter. Clean inside the areas outlined in blue.
2. Repeat as necessary to remove any adhesive or contaminate residue after it dries.

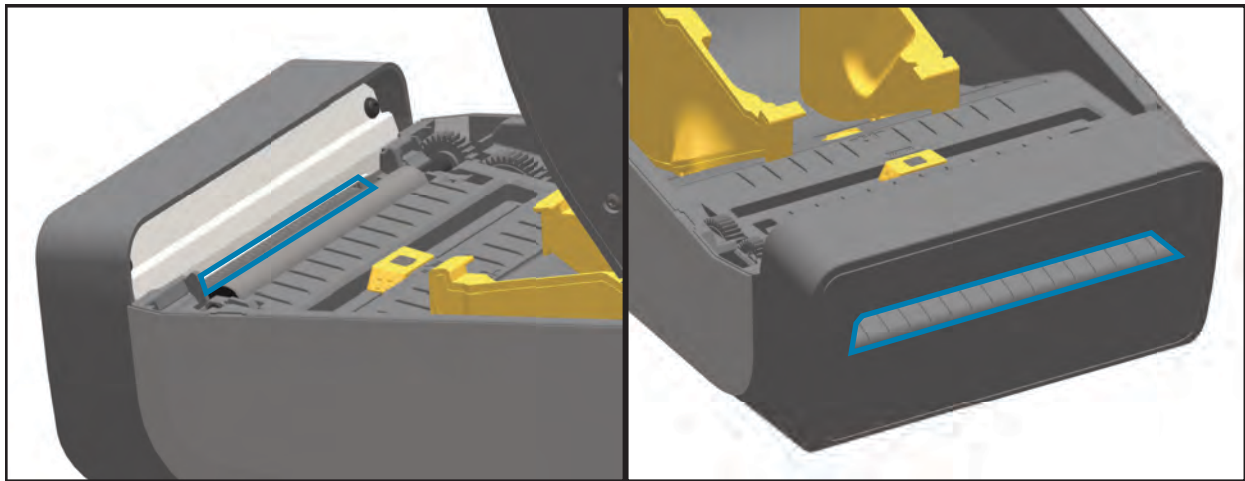

Label Dispenser

1. Open the door and clean the peel bar, inner surfaces and ridges on the door.
2. Wipe the roller while rotating it. Discard the swab or cloth and clean again to remove residue.
3. Clean the sensor window. The window should be clear of streaks and residue.

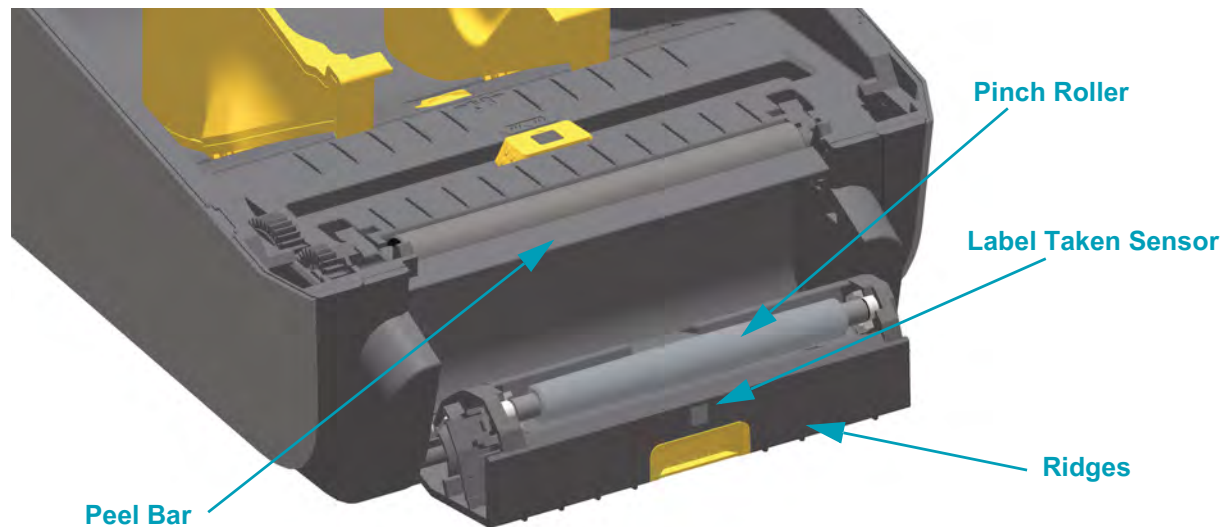

Sensor Cleaning

Dust can accumulate on the media sensors. Do not use an air compressor to remove dust. Compressors add moisture, fine grit, and lubricant which can contaminate your printer.

1. Pull the two (2) Release Arms out to release the Ribbon Drive Transport. The arms are located on the left and right sides of the printer. The Ribbon Drive Transport and Printhead Actuator Arm will now be loose.

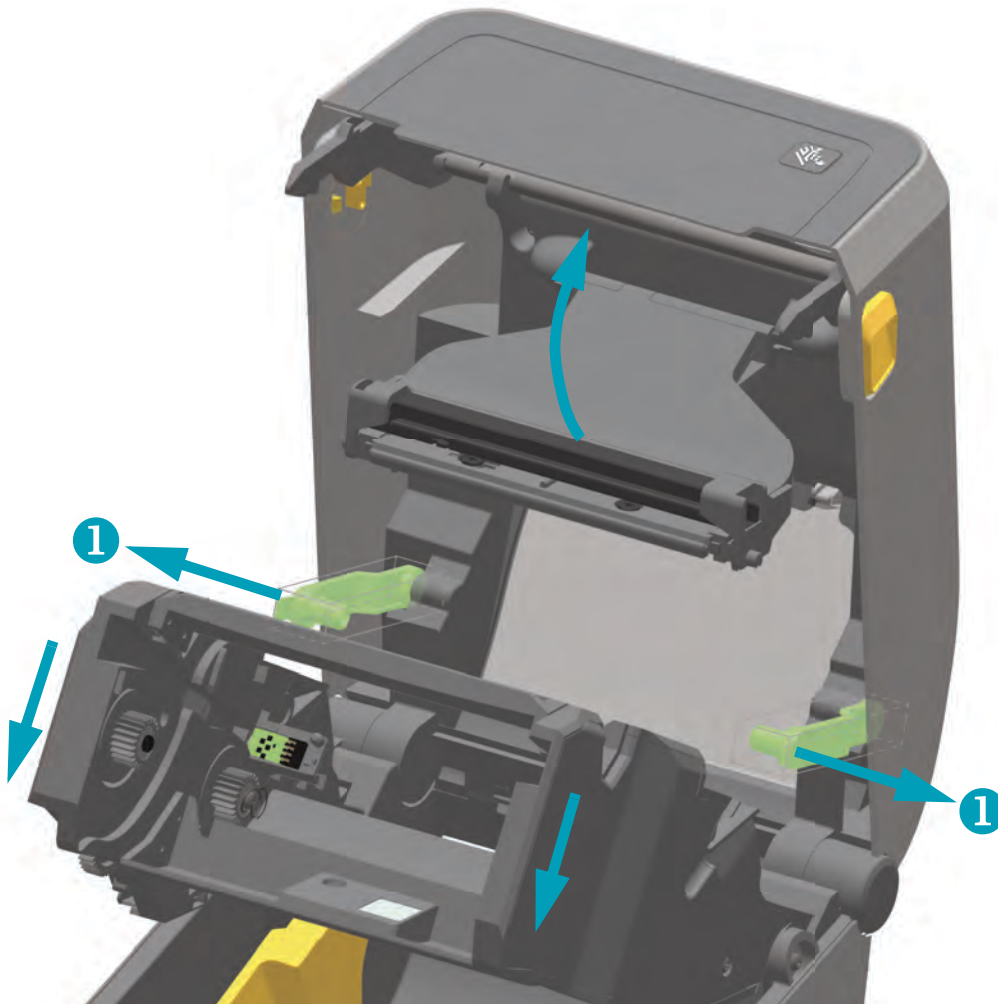

2. Swing the Printhead Actuator Arm up until it touches the printer's top cover. Hold the Printhead Actuator Arm in this position for access to the area below the printhead, see the next graphic.

3. Spray the Upper Web (Gap) Array Sensor under the Ribbon Drive Transport and the Ribbon Out Sensor on the underside of the Printhead Actuator Arm with a can of compressed air. If necessary, use an alcohol moistened swab to break it up. Use a dry swab to remove any residue that may be left from the first cleaning.

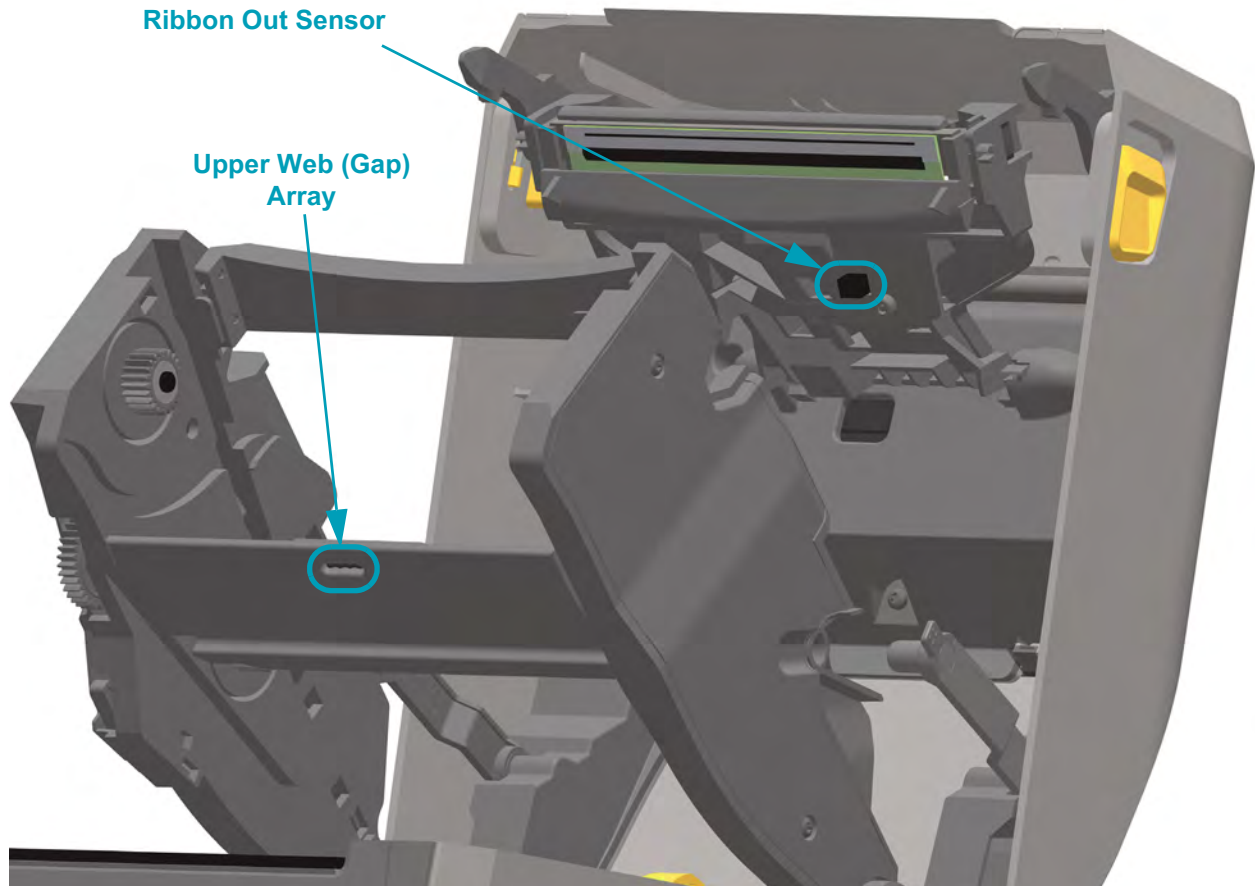

4. Clean the Movable Sensor's window. Gently brush away dust or use a can of compressed air; if necessary, use a dry swab to brush away dust. If adhesives or other contaminants remain, use an alcohol moistened swab to break it up.
5. Use a dry swab to remove any residue that may be left from the first cleaning.
6. Repeat steps 4 and 5 as required until all residue and streaks are removed from the sensor.

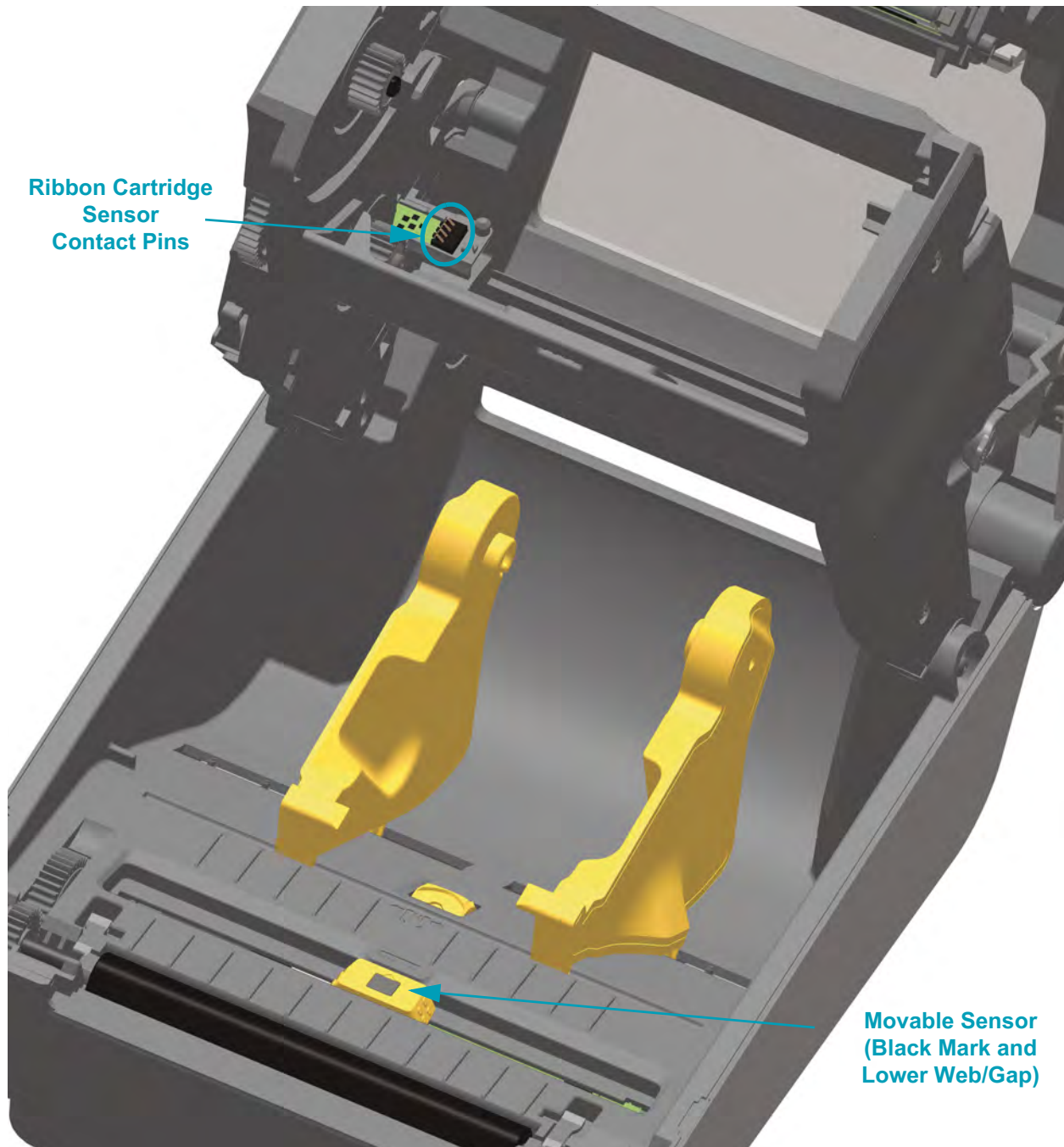

7. **Ribbon Cartridge Sensor Pins - Only clean when the cartridges are failing detection.** Clean the Ribbon Cartridge interface pins with a gentle wiping from right to left. Up and down motions may damage the pins.

Platen Cleaning and Replacement

The platen (drive roller) normally does not require cleaning. Paper and liner dust can accumulate without affecting print operations.

Contaminates on the platen roller can damage the printhead or cause the media to slip or stick when printing. Adhesive, dirt, general dust, oils and other contaminants should be cleaned immediately off the platen.

Clean the platen (and media path) whenever the printer has significantly poorer performance, print quality or media handling. The platen is the print surface and drive roller for your media. If sticking or jamming continues even after cleaning, you must replace the platen.

The platen can be cleaned with a fiber-free swab (such as a Texpad swab) or a lint free, clean, damp cloth very lightly moistened with medical grade alcohol (90% pure or better).

1. Open the cover (and dispenser door if the dispenser is installed). Remove media from platen area.
2. Pull the platen bearing latch release tabs on the right and left sides towards the front of the printer and rotate them up.

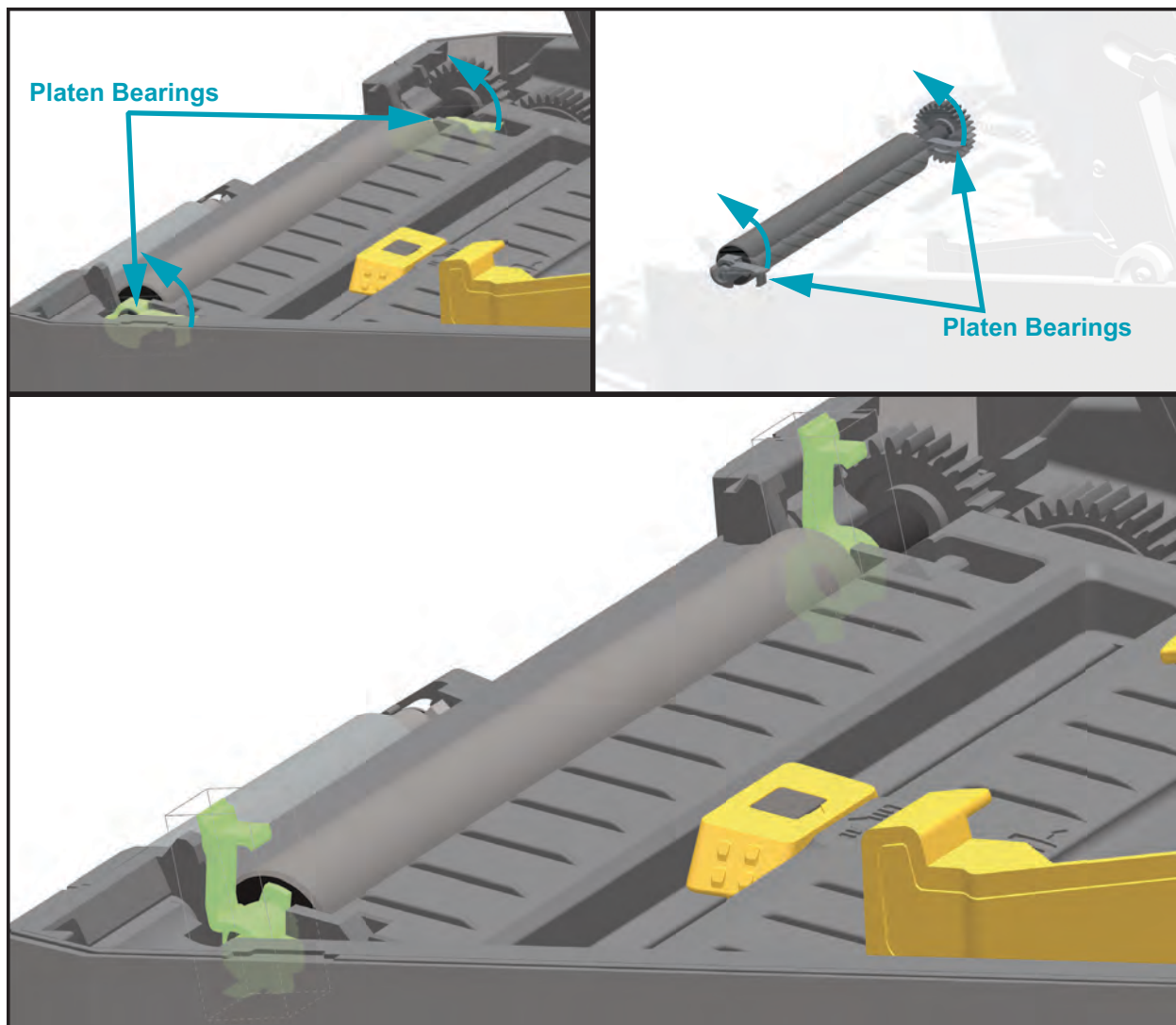

3. Lift the platen out of the printer's bottom frame.

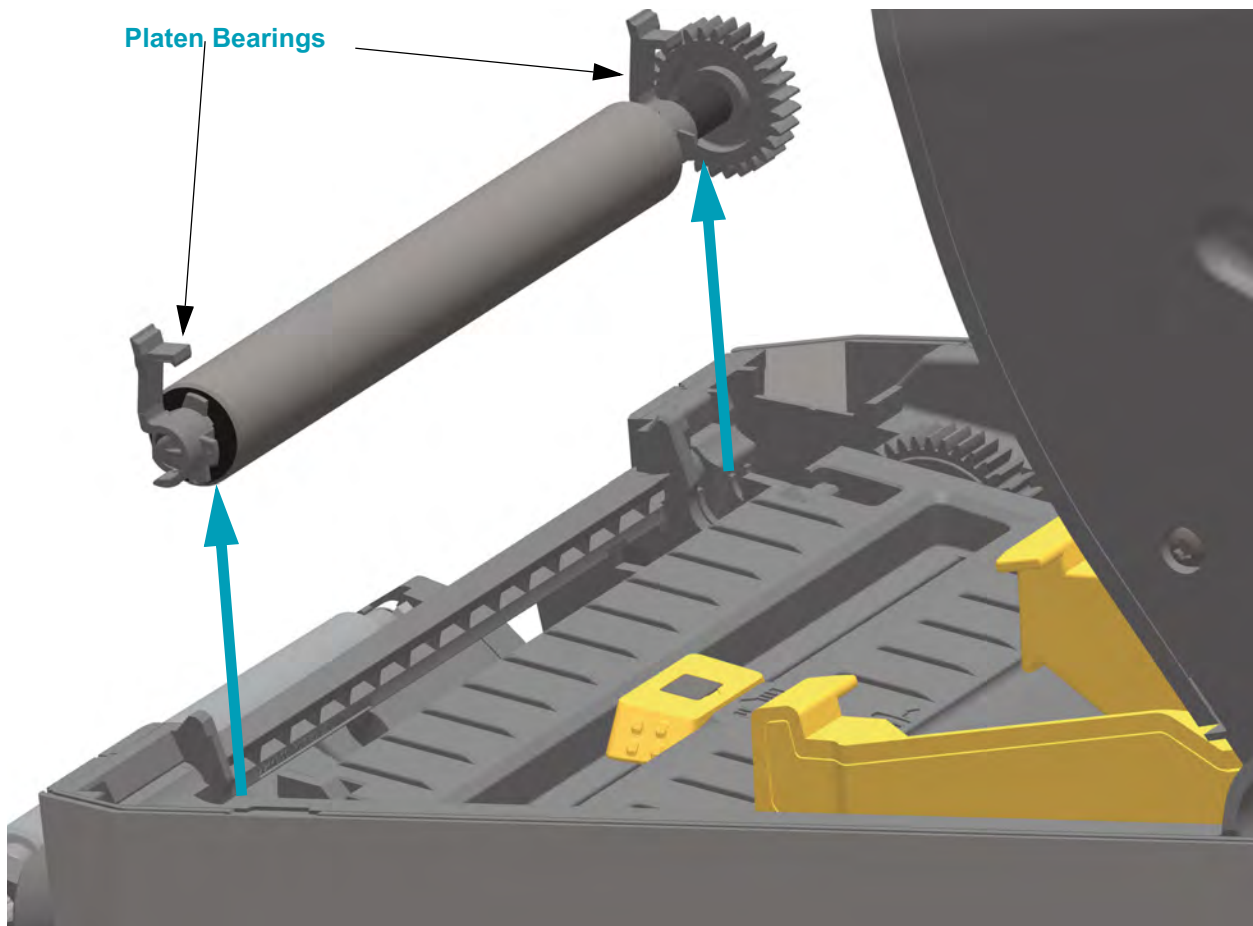

4. Slide the gear and the two (2) bearings off the shaft of the platen roller.

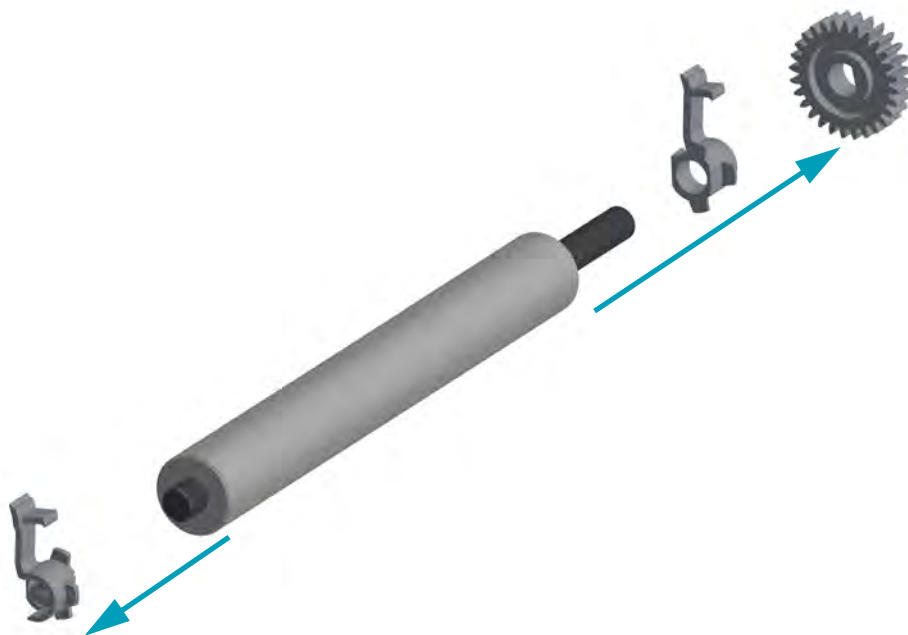

5. **Cleaning Only** - Clean the platen with the alcohol moistened swab. Clean from the center out. Repeat this process until all of the roller surface has been cleaned. If there has been heavy adhesive build-up or label jam, repeat with a new swab to remove residual contaminants. Adhesives and oils, for example, may be thinned by the initial cleaning but not completely removed.
6. **Cleaning Only** - Discard the cleaning swabs after use - do not reuse.
7. Make sure the bearings and drive gear are on the shaft of the platen roller.

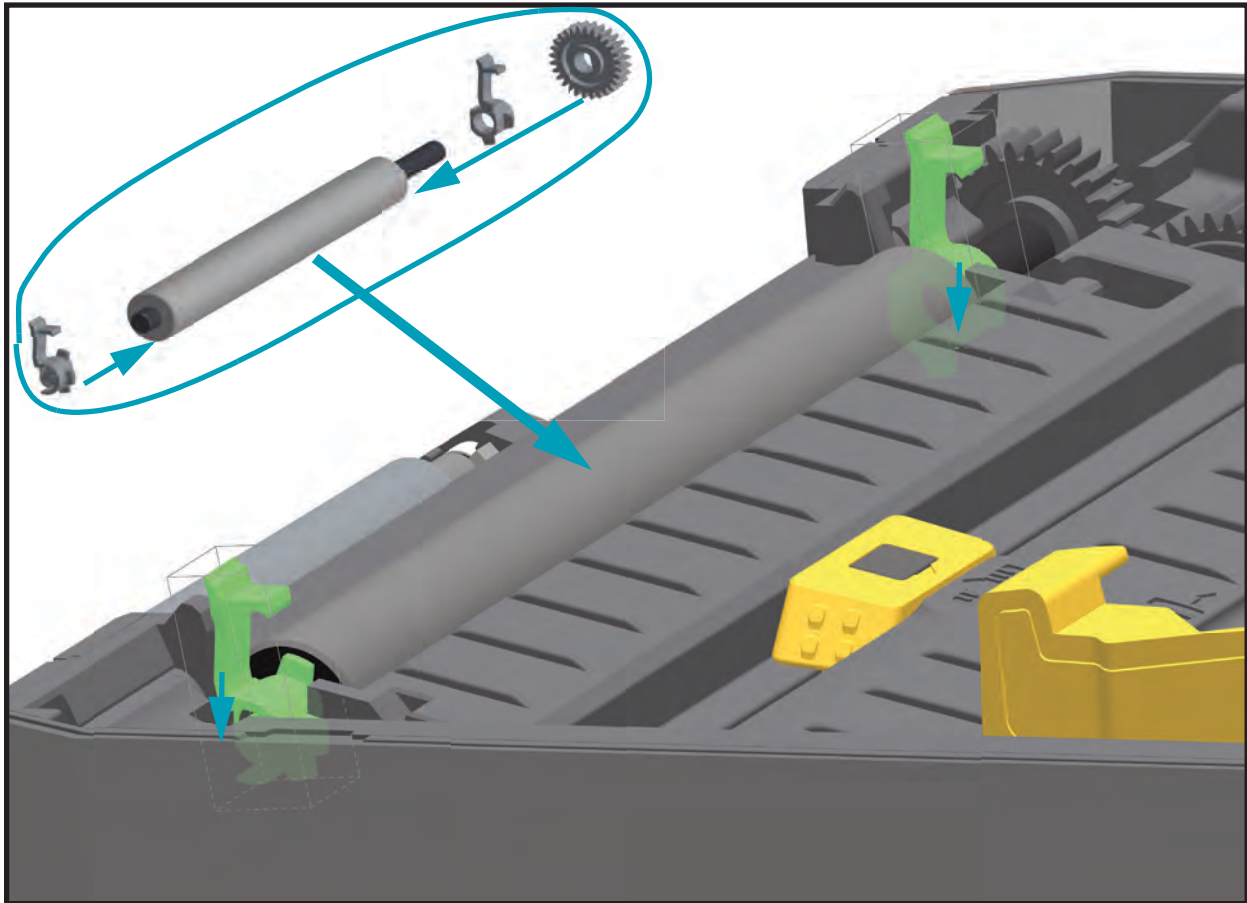

8. Align the platen with the gear to the left and lower it into the printer's bottom frame.
9. Rotate the platen bearing latch release tabs down on the right and left sides towards the rear of the printer and snap them into place.

Allow the printer to dry for one minute before closing the dispenser door, media cover or loading labels.

Other Printer Maintenance

There are no user level maintenance procedures beyond those detailed in this section. See the [Troubleshooting on page 83](#) for more information on diagnosing printer and print problems.

RTC Battery

The RTC (Real-Time Clock) battery is not operator replaceable. See a Zebra authorized service technician to replace the battery. The battery has been rated for up to ten (10) years of operation.



Caution • The printer has a three volt lithium battery. You can discern a low or flat battery if the printer provides a consistently delayed date stamp. Battery replacement must be performed by a qualified service technician. Only use a Zebra approved replacement battery.



Important • Recycle batteries according to local your guidelines and regulations. Wrap the battery when disposing (or storing) to avoid a short circuit.

DO NOT short circuit the battery. Short circuiting the battery may result in heat generation, fire or bursting.

DO NOT heat, disassemble or dispose of battery in fire.

Fuses

There are no replaceable fuses in the ZD420 printer or power supply.

Replacing the Printhead

If you need to replace the printhead, read the procedure and review the removal and installation steps before actually replacing the printhead.



Caution • Prepare your work area by protecting against static discharge. Your work area must be static-safe and include a properly grounded conductive cushioned mat to hold the printer and a conductive wrist strap for yourself.



Caution • Turn the printer power off and unplug the power cord before replacing the printhead.

Before following the steps in this procedure, open the printer by pulling the release latches forward then lifting the top cover.

Printhead Removal

1. Turn the printer OFF. Open the printer.
2. Pull the two (2) Release Arms out to release the Ribbon Drive Transport. The arms are located on the left and right sides of the printer. The Ribbon Drive Transport and Printhead Actuator Arm will now be loose.

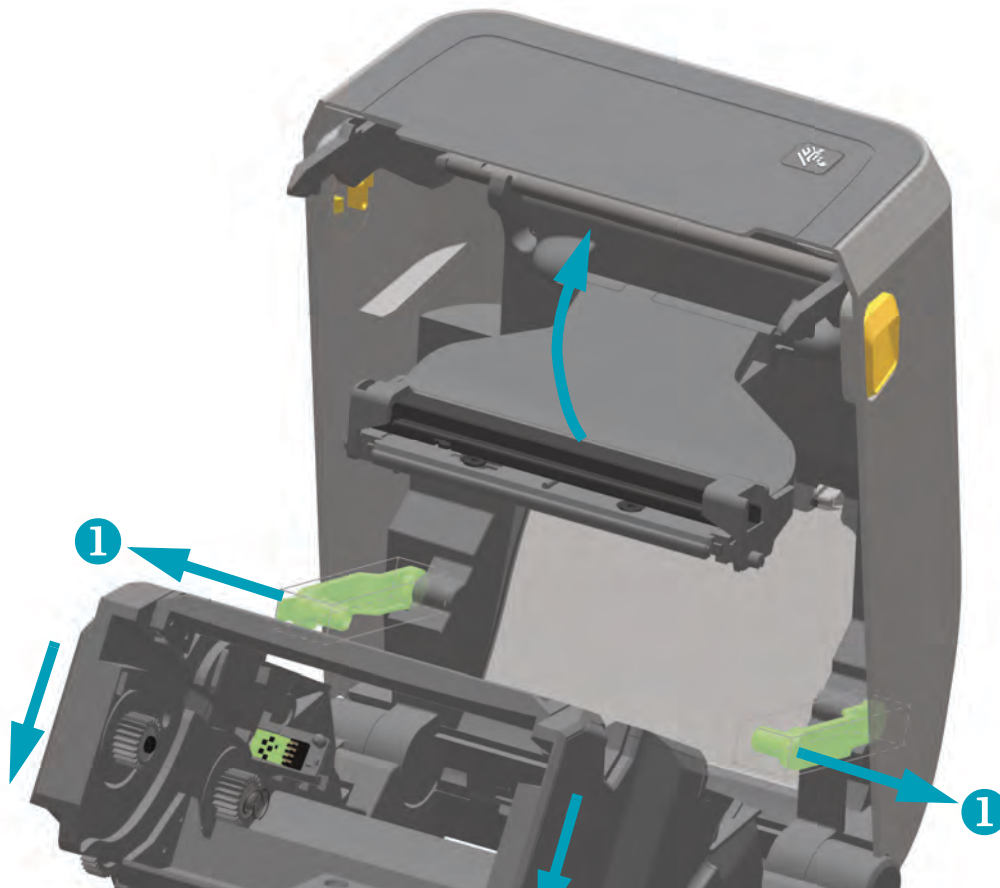

3. Swing the Printhead Actuator Arm up until it touches the printer's top cover. Hold the Printhead Actuator Arm in this position for access to the printhead, see the next graphic.
4. Push the printhead release latch toward the printhead (shown as pink for visibility). The right side printhead releases down and away from the Printhead Actuator Arm.

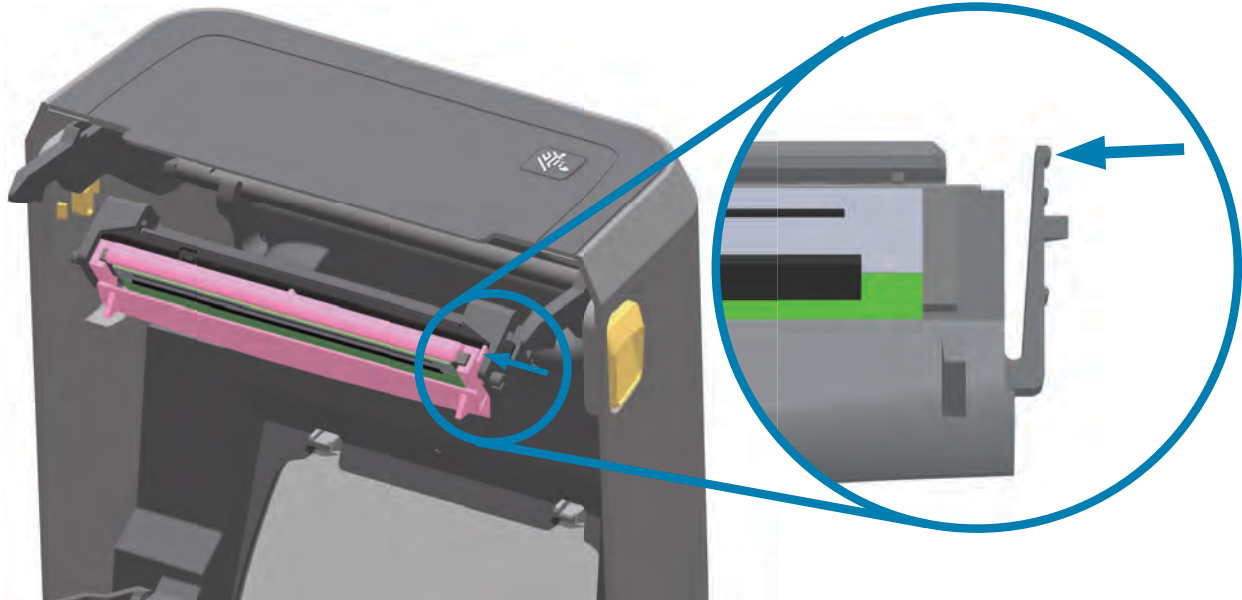

5. Swing the loose right side of the printhead out of the printer. Pull it to the right a little to get the left side of the printhead clear. Pull the printhead down and free of the Printhead Actuator Arm to gain access to its attached cables.

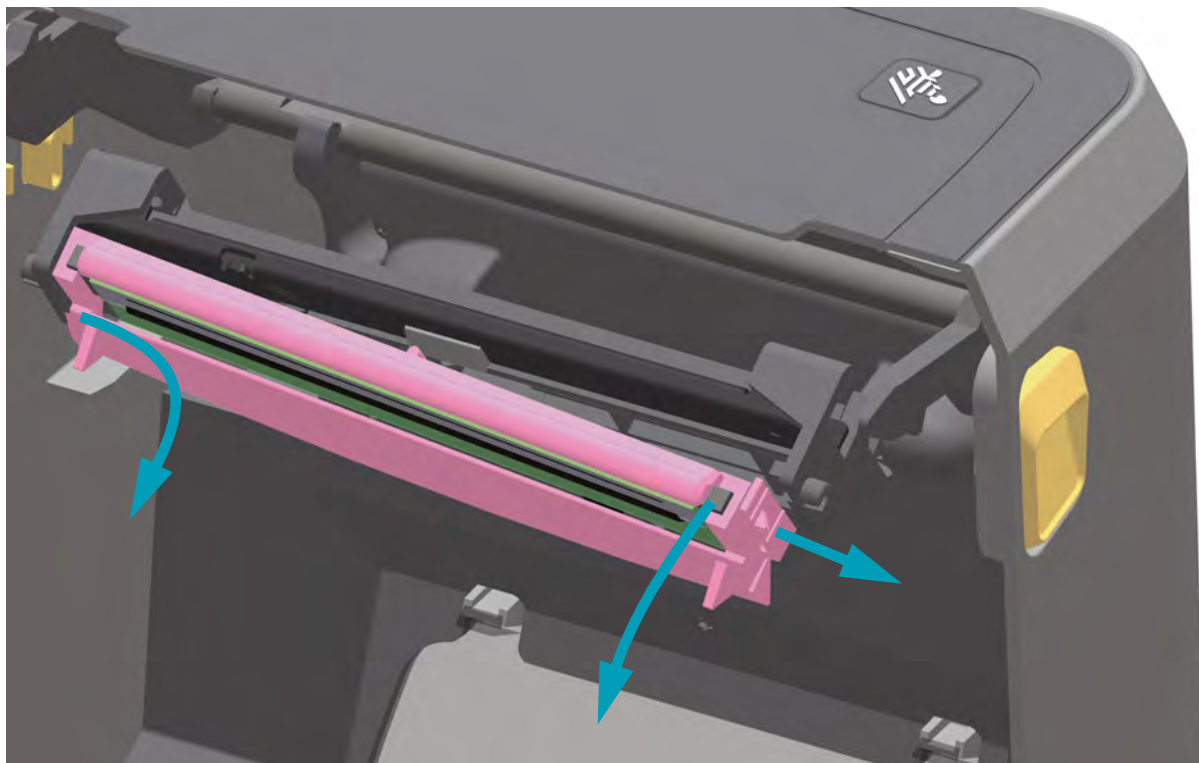

6. Gently but firmly pull the two printhead cable bundle connectors off of the printhead.

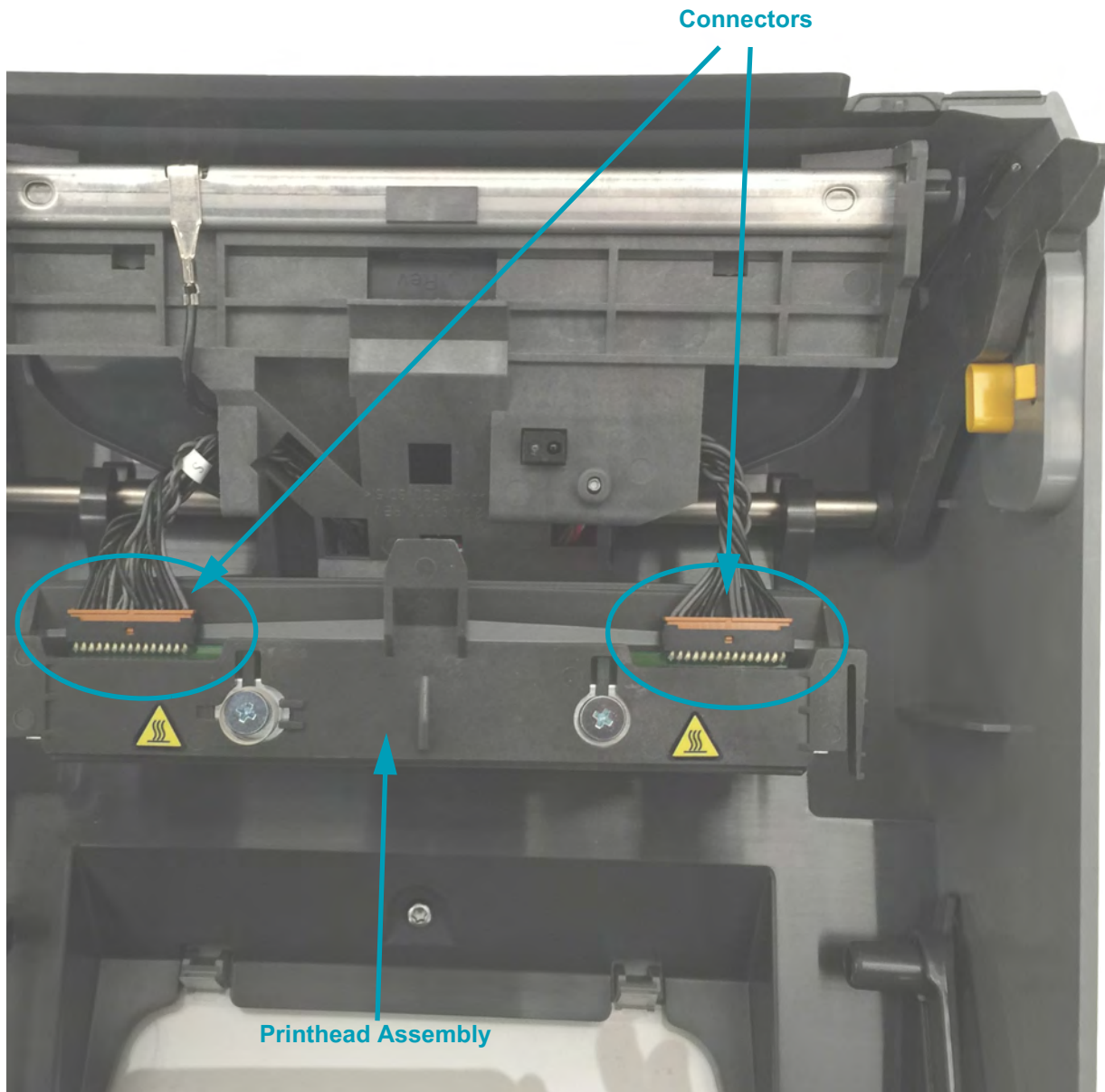

Replacing the Printhead

1. Push the right side printhead cable connector into the printhead. The connector is keyed to only insert one way.
2. Push the left side printhead cable connector onto the printhead.
3. Insert the center tab on the printhead assembly into the center slot on the Printhead Actuator Arm.

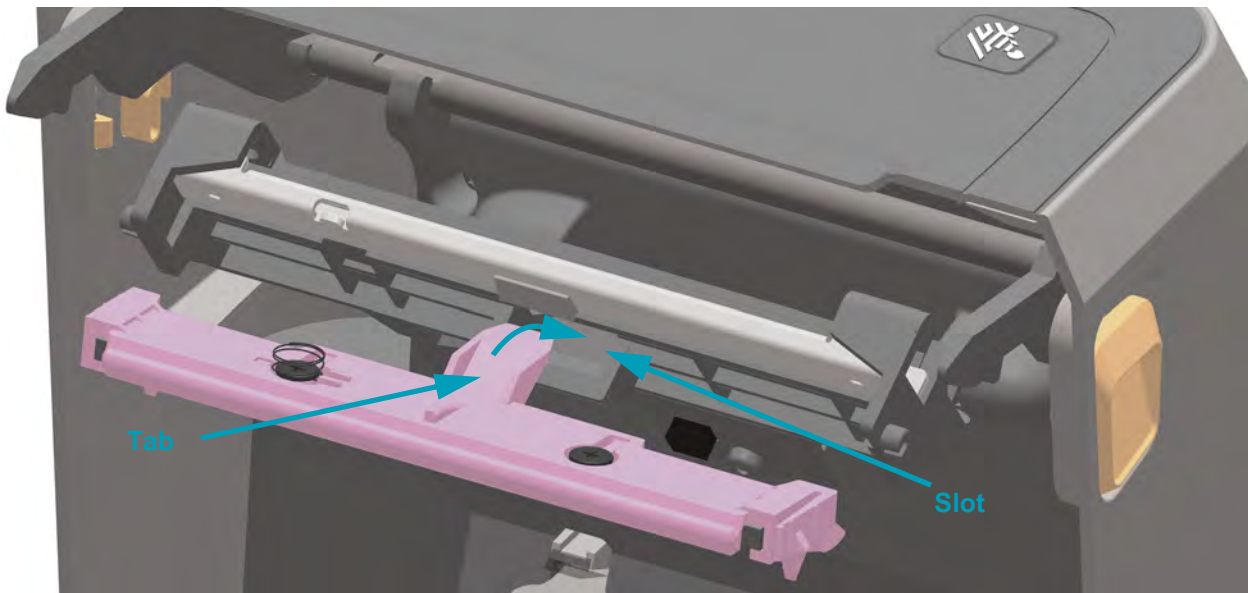

4. Insert the left side tab of the printhead assembly into the recessed slot on the left side of the Printhead Actuator Arm.

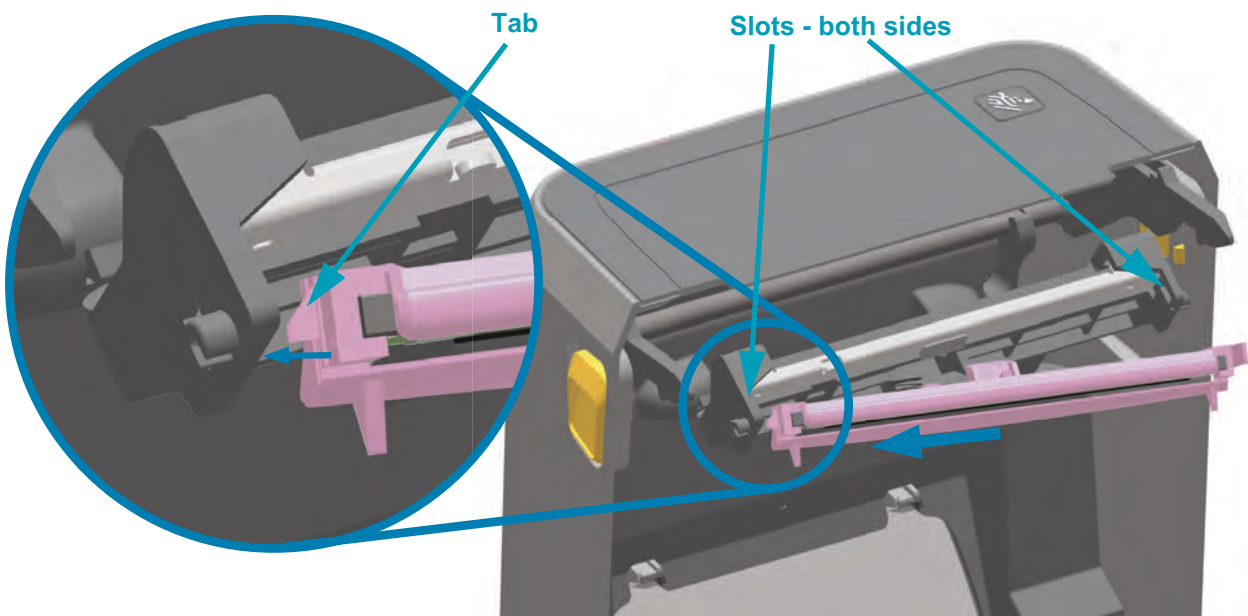

5. Push the right side of the printhead into the printer until the latch locks the right side of the printhead into the printer.

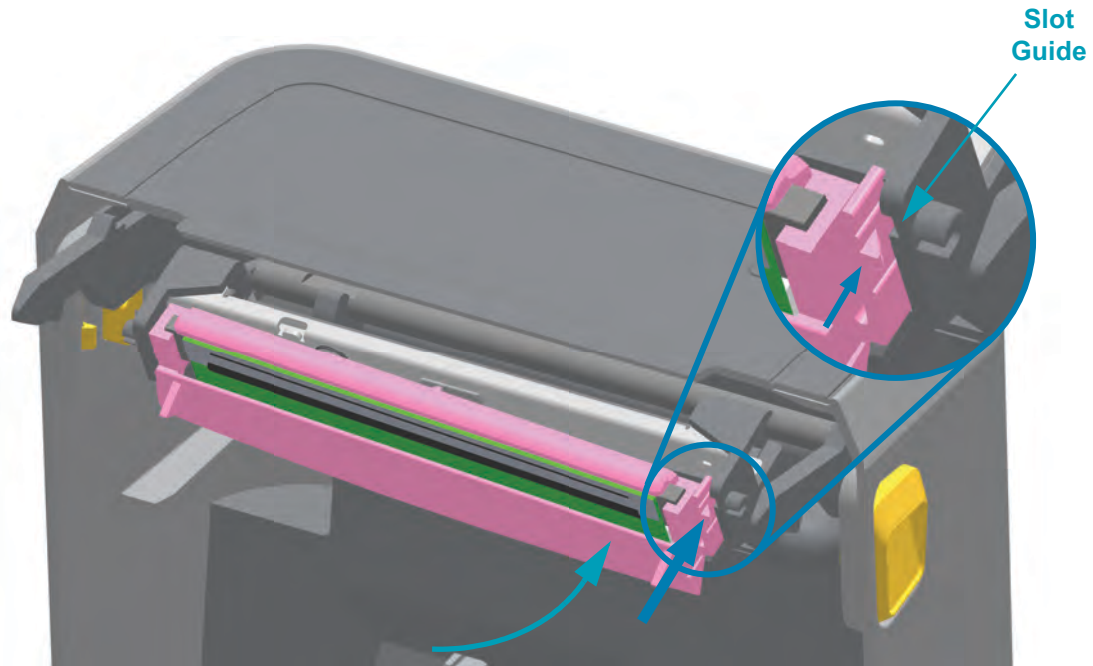

6. Verify that the printhead moves freely into the printer when pressure is applied (see arrow) and remains locked when pressure is released.



7. Clean the printhead by using a new cleaning pen to wipe body oils (finger prints) and debris off the printhead. Clean from the center of the printhead to the outside. See [Cleaning the Printhead on page 115](#).
8. Reload media. Turn on the printer and print a status report to ensure proper function. See [Test Printing with the Configuration Report on page 41](#).

A

Appendix: Interface Wiring

This section provides wiring diagrams for typical interface cables.

Universal Serial Bus (USB) Interface

The figure below displays the cable wiring required to use the printer's USB interface.

The printer requires cable or cable packaging that bears the "Certified USB™" mark to guarantee USB 2.0 compliance.

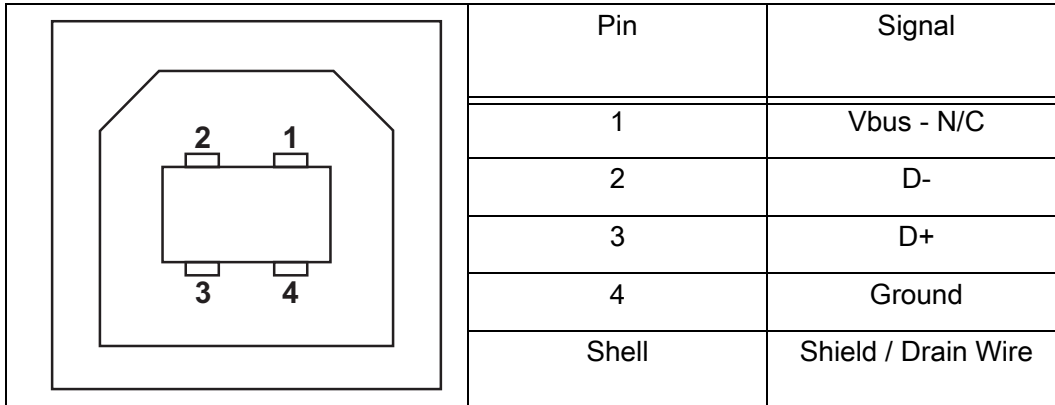

For information on the USB interface, go to the USB web site at:

<http://www.usb.org>

Serial Port Interface - Auto-detecting DTE and DCE

Pin	DTE	DCE	Description (DTE)
1	—	5V	Not used
2	RXD	TXD	RXD (receive data) input to the printer
3	TXD	RXD	TXD (transmit data) output from the printer
4	DTR	DSR	DTR (data terminal ready) output from the printer -- controls when the host may send data
5	GND	GND	Circuit ground
6	DSR	DTR	DSR (data set ready) input to the printer
7	RTS	CTS	RTS (request to send) output from the printer -- always in the ACTIVE condition when the printer is turned on
8	CTS	RTS	CTS (clear to send) - Not used by the printer
9	5V	—	+5 V @ 0.75 A - FET Circuit current limited

The maximum current available through the serial and/or both USB port is not to exceed a total of 0.75 Amps.

When XON/XOFF handshaking is selected, data flow is controlled by the ASCII control codes DC1 (XON) and DC3 (XOFF). The DTR control lead will have no effect.

Interconnecting to DTE Devices — The printer is configured as data terminal equipment (DTE). To connect the printer to other DTE devices (such as the serial port of a personal computer), use an RS-232 null modem (crossover) cable. Figure 31 shows the required cable connections.

Interconnecting to DCE Devices — When the printer is connected via its RS-232 interface to data communication equipment (DCE) such as a modem, a STANDARD RS-232 (straight-through) interface cable must be used. Figure 32 shows the connections required for this cable.

Connecting the Printer to a DTE Device

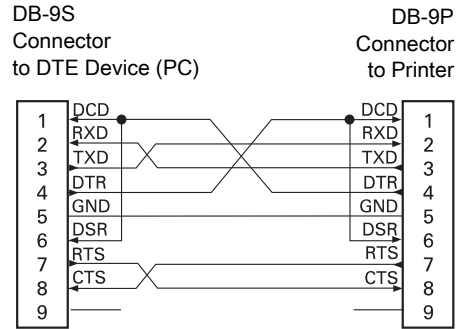
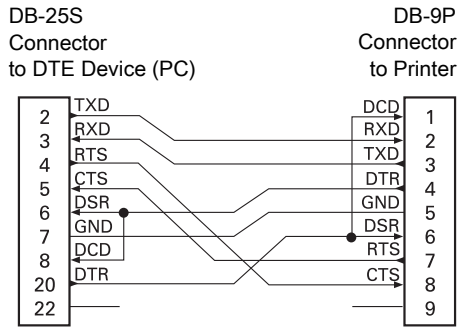

Connecting the Printer to a DCE Device

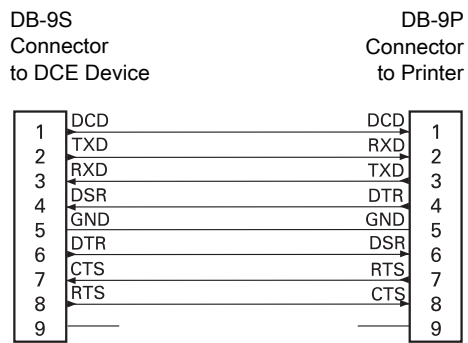
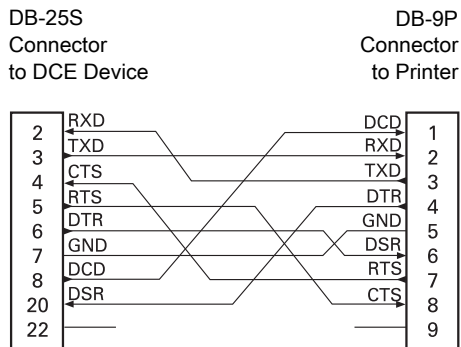

Appendix: Dimensions

This section provides external printer dimensions.

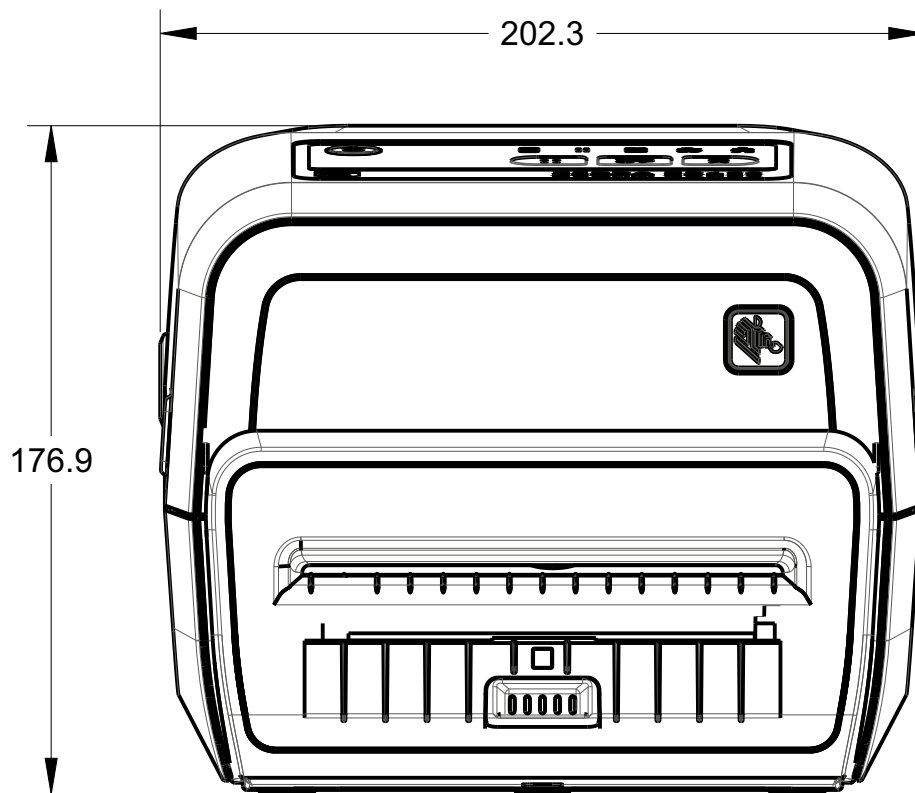

Dimensions are in millimeters (mm)

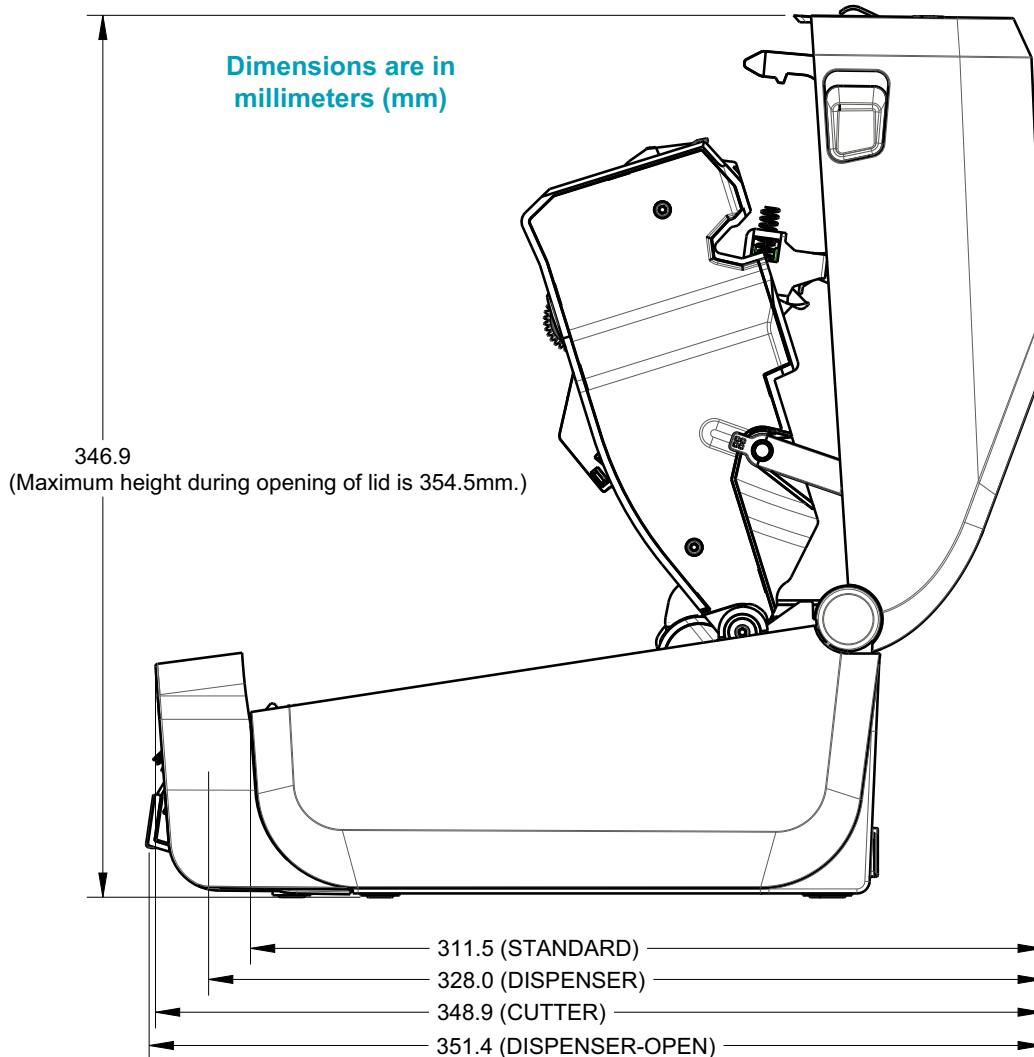
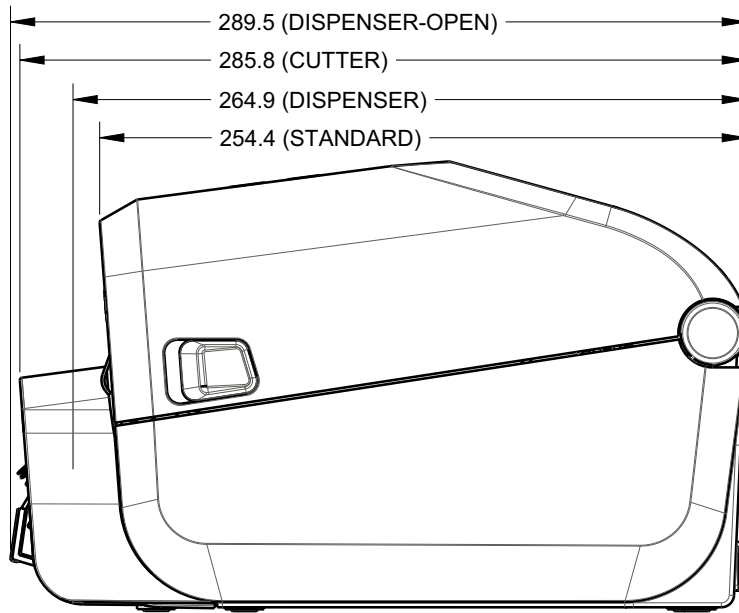

Use M3 thread forming screws with maximum hole depth of 6 mm into the printer body.

Note - Do not remove the rubber feet or the printer can overheat.

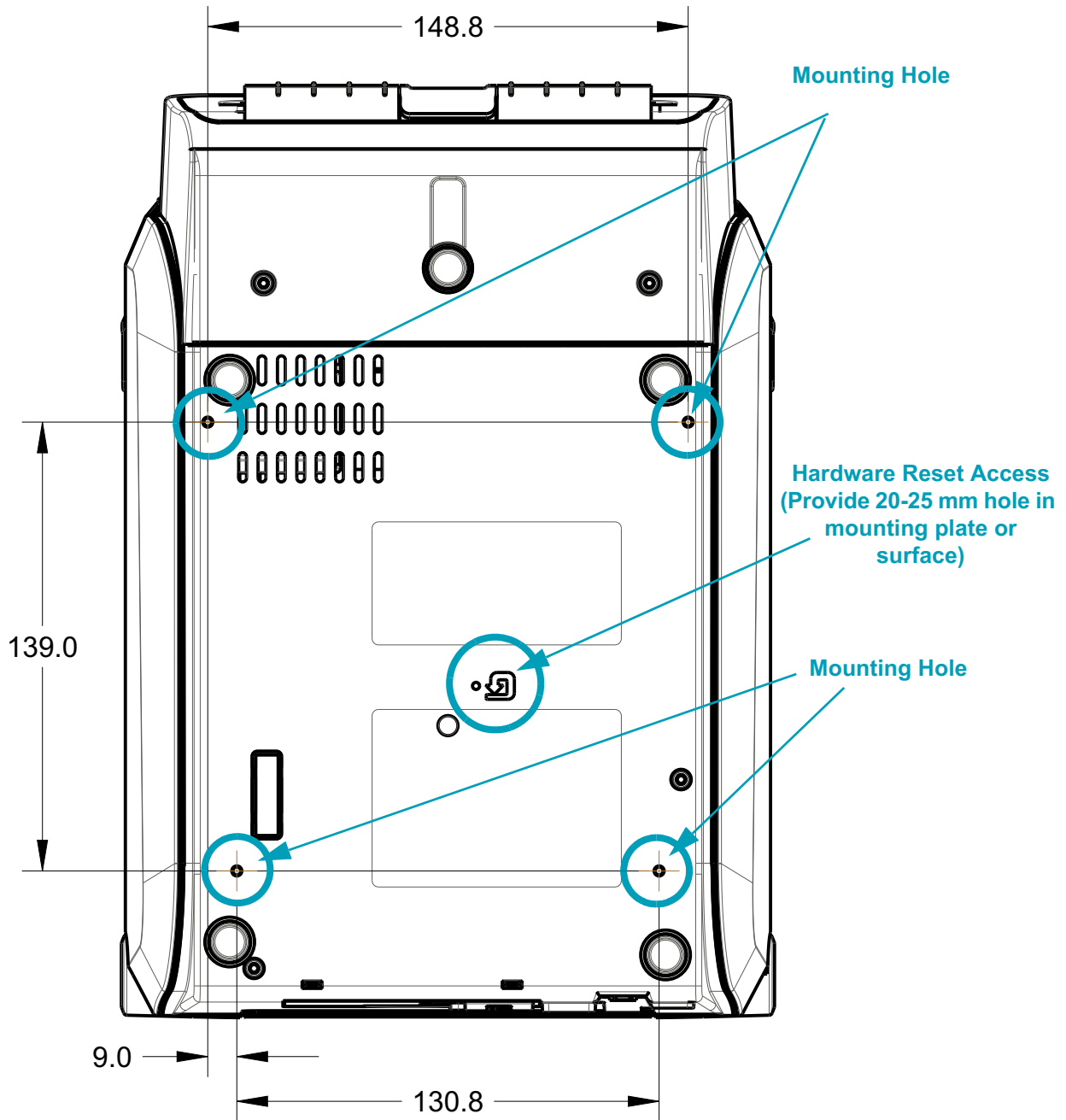

Dimensions are in millimeters (mm)

Appendix: Media

This section provides a simple media overview for your printer.

Types of Thermal Media



Important • Zebra strongly recommends the use of Zebra-brand supplies in order to ensure consistent high-quality printing. A wide range of paper, polypropylene, polyester, and vinyl stock has been specifically engineered to enhance the printing capabilities of the printer and to prevent premature printhead wear. To purchase supplies, go to <http://www.zebra.com/howtobuy>.

Your printer can use various types of media:

- **Standard media**—Most standard (non-continuous) media uses an adhesive backing that sticks individual labels or a continuous length of labels to a liner.
- **Continuous roll media**—Most continuous roll media is direct thermal media (similar to FAX paper) and is used for receipt or ticket style printing.
- **Tag stock**—Tags are usually made from a heavy paper (up to 0.0075in./0.19mm thick). Tag stock does not have adhesive or a liner, and it is typically perforated between tags.

For more information on basic media types, see [Table 1](#).

The printer typically uses roll media, but you can use fan-fold or other continuous media too.

Determining Thermal Media Types

Thermal transfer media requires ribbon for printing while direct thermal media does not. To determine if ribbon must be used with a particular media, perform a media scratch test.

To perform a media scratch test, complete these steps:

1. Scratch the print surface of the media with a finger nail or pen cap. Press firmly and quickly while dragging it across the media surface. Direct thermal media is chemically treated to print (expose) when heat is applied. This test method uses friction heat to expose the media.
2. Did a black mark appear on the media?

If a black mark...	Then the media is...
Appears on the media	Direct thermal. No ribbon is required.
Does not appear on the media	Thermal transfer. A ribbon is required. Not supported by this printer.

General Media and Print Specifications

- Media thickness:
 - 0.08mm (0.003 inch) min – all requirements
 - 0.1905mm (0.0075 inch) max – all requirements
- Media width:
 - 60mm (2.36 inch) max
 - 15mm (0.585 inch) min
- Media length:
 - 990mm (39 inch) max
 - 6.35mm (0.25 inch) min – Tear Off or Label
 - 12.7mm(0.50 inch) min – Peel
 - 25.4mm (1.0 inch) min - Cutter
- Media Roll Outer Diameter (O.D.) max: 127mm
- Media Roll Core Inner Diameter (I.D.):
 - 12.7mm (0.5 inch) I.D. - Standard roll configuration
 - 25.4mm (1 inch) I.D. - Standard roll configuration
 - 38.1mm (1.5 inches) I.D. - with optional media roll adapter
 - 50.8mm (2.0 inches) I.D. - with optional media roll adapter
 - 76.2mm (3.0 inches) I.D. - with optional media roll adapter
- Print width:
 - 1 dot (ZPL) min.
 - 56mm (2.20 inches) max @ 203 dpi
 - 54mm (2.12 inches) max @ 300 dpi
- Dot pitch:
 - 203 dpi: 0.125mm (0.0049 inch)
 - 300 dpi: 0.085mm (0.0033 inch)
- Barcode modulus x-dim:
 - 203 dpi: 0.005-0.050 inch
 - 300 dpi: 0.00327 - 0.03267 inch
- ZD420 Ribbon Cartridges
 - Ribbon Length - 74 m (243 feet)
 - Ribbon Widths - 110 mm (4.33 in.)
 - Colors available in Black - Wax, Wax Resin, and Resin transfer materials

Table 1 • Types of Media Roll and Fanfold Media

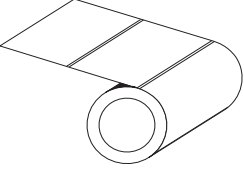
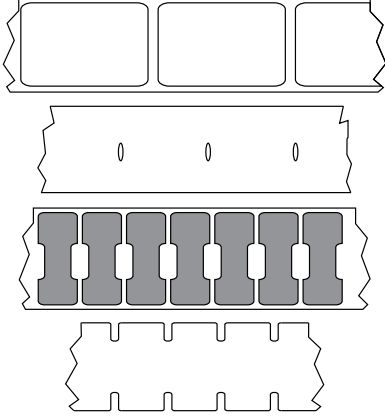
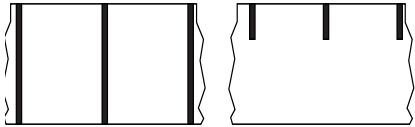
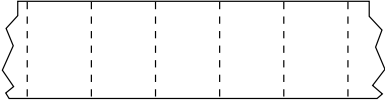
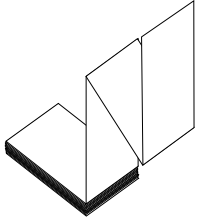
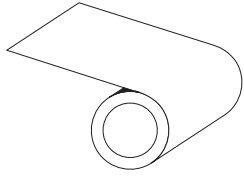
Media Type	How It Looks	Description
<p>Non-Continuous Roll Media</p>		<p>Labels have adhesive backing that sticks them to a liner. Tags (or tickets) are separated by perforations.</p> <p>Individual labels or tags are tracked and position controlled by one or more of the following methods:</p> <ul style="list-style-type: none"> Web media separates labels by gaps, holes, or notches. <div style="text-align: center;">  </div> Black mark media uses pre-printed black marks on the back side of the media to indicate label separations. <div style="text-align: center;">  </div> Perforated media has perforations that allow the labels or tags to be separated from each other easily in addition to position control marks, notches or label gaps. <div style="text-align: center;">  </div>
<p>Non-Continuous Fanfold Media</p>		<p>Fan-Fold media is folded in a zigzag pattern. Fanfold media can have the same label separations as non-continuous roll media. The separations would fall on or near the folds.</p> <p>This type of media uses black marks or notches to track media format positioning.</p>
<p>Continuous Roll Media</p>		<p>Continuous roll media does not have gaps or typically holes, notches, or black marks either to indicate label separations. This allows the image to be printed anywhere on the label. A cutter can be used to cut apart individual labels. With continuous media, use the transmissive (gap) sensor so the printer can detect when the media runs out.</p>

Appendix: ZPL Configuration

This section provides an overview of managing printer configuration, the Configuring Status Printout, and Printer Memory Printouts.

Managing the ZPL Printer Configuration

The ZPL printer is designed to allow you to change printer settings dynamically for fast first label out printing. Printer parameters that are persistent, will be retained for future formats to use. Those settings will remain in effect until they are changed by subsequent commands, the printer is reset, power is cycled, or when you restore a parameter that has a factory default by resetting the printer to factory defaults. The ZPL Configuration Update command (^JUS) saves and restores printer configurations to initialize (or re-initialize) the printer with pre-configured settings.

- To keep settings after a power cycle or printer reset, a ^JUS can be sent to the printer to save all current persistent settings.
- The values are recalled with a ^JUR command to restore the last saved values to the printer.

ZPL stores all parameters at once with a single command mentioned above. The legacy EPL programming language (supported by this printer) changes and saves individual commands immediately. Most printer settings are shared between ZPL and EPL. For example, changing the speed setting with EPL will also change the speed set for ZPL operations. The changed EPL setting will persist even after a power cycle or reset issued by either printer language.

A printer Configuration Report is available to assist the developer. The Configuration Report lists operating parameters, sensor settings, and printer status. It can be accessed by using the procedure in [Test Printing with the Configuration Report on page 41](#). The Zebra Setup Utility and the ZebraDesigner™ Windows driver also print this report and other printer reports to help you manage your printer.

ZPL Printer Configuration Format

Managing more than one printer can be done by creating a printer configuration programming file to send to one or more printers or ZebraNet™ Bridge can be used to clone a printer's setup. Figure 1 below shows the basic structure of a ZPL programming configuration file.

See the ZPL programmer's guide and the [Configuration Setting to Command Cross-reference on page 146](#) to create a programming file. The Zebra Setup Utility (ZSU) can be used to send programming files to the printer. Windows Notepad (text editor) can be used to create programming files.

Figure 1 • Configuration Parameter Format Structure

^XA — Start Format Command

Format Commands are order sensitive

- a) General Print and command settings
- b) Media handling and behaviors
- c) Media print size

^JUS command to save

^XZ — End Format Command

Configuration Setting to Command Cross-reference

The Printer Configuration Report, shown below, provides a listing of a majority of the configurations settings that can be set by ZPL command.

Figure 2 • Configuration Report Printout

PRINTER CONFIGURATION	
Zebra Technologies ZTC ZD420-203dpi ZPL 50J154800145	
+10.0.....	DARKNESS
HIGH.....	DARKNESS SWITCH
6.0 IPS.....	PRINT SPEED
+000.....	TEAR OFF
TEAR OFF.....	PRINT MODE
GAP/NOTCH.....	MEDIA TYPE
TRANSMISSIVE.....	SENSOR SELECT
THERMAL-TRANS.....	PRINT METHOD
832.....	PRINT WIDTH
1224.....	LABEL LENGTH
39.0IN 988MM.....	MAXIMUM LENGTH
MAINT. OFF.....	EARLY WARNING
NOT CONNECTED.....	USB COMM.
AUTO.....	SER COMM. MODE
9600.....	BAUD
8 BITS.....	DATA BITS
NONE.....	PARITY
XON/XOFF.....	HOST HANDSHAKE
NONE.....	PROTOCOL
NORMAL MODE.....	COMMUNICATIONS
<~> 7EH.....	CONTROL PREFIX
<^> 5EH.....	FORMAT PREFIX
<, > 2CH.....	DELIMITER CHAR
ZPL II.....	ZPL MODE
INACTIVE.....	COMMAND OVERRIDE
NO MOTION.....	MEDIA POWER UP
FEED.....	HEAD CLOSE
DEFAULT.....	BACKFEED
+000.....	LABEL TOP
+0000.....	LEFT POSITION
10.....	RIBBON LOW MODE
DISABLED.....	REPRINT MODE
041.....	WEB SENSOR
096.....	MEDIA SENSOR
075.....	RIBBON SENSOR
128.....	TAKE LABEL
069.....	MARK SENSOR
004.....	MARK MED SENSOR
048.....	TRANS GAIN
028.....	TRANS LED
040.....	RIBBON GAIN
076.....	MARK GAIN
070.....	MARK LED
DPCSWFXM.....	MODES ENABLED
.....	MODES DISABLED
832 8/MM FULL.....	RESOLUTION
3.2.....	LINK-OS VERSION
V77.19.152P31840 <-	FIRMWARE
1.3.....	XML SCHEMA
6.5.0 0.517.....	HARDWARE ID
8192k.....R:	RAM
65536k.....E:	ONBOARD FLASH
NONE.....	FORMAT CONVERT
ENABLED.....	IDLE DISPLAY
01/08/16.....	RTC DATE
19:43.....	RTC TIME
DISABLED.....	ZBI
2.1.....	ZBI VERSION
READY.....	ZBI STATUS
28 LABELS.....	NONRESET CNTR
28 LABELS.....	RESET CNTR1
28 LABELS.....	RESET CNTR2
137 IN.....	NONRESET CNTR
137 IN.....	RESET CNTR1
137 IN.....	RESET CNTR2
347 CM.....	NONRESET CNTR
347 CM.....	RESET CNTR1
347 CM.....	RESET CNTR2
EMPTY.....	SLOT 1
0.....	MASS STORAGE COUNT
0.....	HID COUNT
OFF.....	USB HOST LOCK OUT
FIRMWARE IN THIS PRINTER IS COPYRIGHTED	

Sensor Settings
used for
Service Purposes

Table 1 • ZPL Commands and Configuration Report Callout Cross-Reference

Command	Listing Name	Description
~SD	DARKNESS	Default: 10.0
—	DARKNESS SWITCH	LOW (Default), MEDIUM, or HIGH
^PR	PRINT SPEED	Default: 152.4 mm/s / 6 IPS (max.) - 203 dpi 101.6 mm/s / 4 IPS (max.) - 300 dpi
~TA	TEAR OFF	Default: +000
^MN	MEDIA TYPE	Default: GAP/NOTCH
	SENSOR SELECT	Default: AUTO (^MNA - Auto-Detect)
^MT	PRINT METHOD	THERMAL-TRANS or DIRECT-THERMAL
^PW	PRINT WIDTH	Default: 448 (dots for 203 dpi) or 640(dots for 300 dpi)
^LL	LABEL LENGTH	Default: 1225 (dots) (dynamically updated while printing)
^ML	MAXIMUM LENGTH	Default: 39.0IN 989MM
—	USB COMM.	Connection Status: Connected / Not Connected
^SCa	BAUD	Default: 9600
^SC,b	DATA BITS	Default: 8 BITS
^SC,,c	PARITY	Default: NONE
^SC,,,,e	HOST HANDSHAKE	Default: AUTO
^SC,,,,,f	PROTOCOL	Default: NONE
— SGD —**	COMMUNICATIONS	Default: NORMAL MODE
	SER COMM. MODE	Default: AUTO
^CT / ~CT	CONTROL CHAR	Default: <~> 7EH
^CC / ~CC	COMMAND CHAR	Default: <^> 5EH
^CD / ~CD	DELIM./CHAR	Default: <, > 2CH
^SZ	ZPL MODE	Default: ZPL II
????	COMMAND OVERRIDE	Default: INACTIVE
^MFA	MEDIA POWER UP	Default: NO MOTION
^MF,b	HEAD CLOSE	Default: FEED
~JS	BACKFEED	Default: DEFAULT
^LT	LABEL TOP	Default: +000
^LS	LEFT POSITION	Default: +0000
~JD / ~JE	HEXDUMP	Default: NO (~JE)
	REPRINT MODE	Default: DISABLED

From this point in the Configuration Receipt listing, the printout has sensor settings and values displayed to troubleshoot sensor and media operations. These are typically used by Zebra Tech Support to diagnose printer problems.

** - Not supported with a ZPL command, uses the Set Get Do command in the ZPL manual. See `device.command_override.xxxxx`.

The configuration settings listed here resume after the **TAKE LABEL** sensor value. These listings contain printer features seldom changed from default or provide status information (e.g. Firmware Version).

Table 2 • ZPL Commands and Configuration Receipt Callout Cross-Reference

Command	Listing Name	Description
^MP	MODES ENABLED	Default: CWF (See ^MP Command)
	MODES DISABLED	Default: (nothing set)
^JM	RESOLUTION	Default: 448 8/mm FULL (203 dpi) 640 8/mm FULL (300 dpi)
–	FIRMWARE	Lists ZPL Firmware Version
–	XML SCHEMA	1.3
–	HARDWARE ID	Lists Firmware Boot-block Version
	LINK-OS VERSION	
–	CONFIGURATION	CUSTOMIZED (after first use)
–	RAM	2104k..... R:
–	ONBOARD FLASH	6144k.....E:
^MU	FORMAT CONVERT	NONE
	RTC DATE	Date Displayed
	RTC TIME	Time Displayed
^JI / ~JI	ZBI	DISABLED (Requires key to enable)
	ZBI VERSION	2.1 (Displayed if installed)
	ZBI STATUS	READY
^JH ^MA ~RO	LAST CLEANED	X,XXX IN
	HEAD USAGE	X,XXX IN
	TOTAL USAGE	X,XXX IN
	RESET CNTR1	X,XXX IN
	RESET CNTR2	X,XXX IN
	NONRESET CNTR0 (1, 2)	X,XXX IN
	RESET CNTR1	X,XXX IN
	RESET CNTR2	X,XXX IN
	SLOT1	EMPTY / SERIAL / WIRED
	MASS STORAGE COUNT	0
	HID COUNT	0
	USB HOST LOCK OUT	OFF / ON
–	SERIAL NUMBER	XXXXXXXXXXXX
^JH	EARLY WARNING	MAINT. OFF

The printer has the ability to set a command or a group of commands once for all receipts (or labels) that follow. Those settings will remain in effect until they are changed by subsequent commands, the printer is reset, or you restore factory defaults.

Printer Memory Management and Related Status Reports

To help you manage printer resources, the printer supports a variety of format commands to manage memory, transfer objects (between memory areas, import and export), object naming, and provide various printer operating status reports. They are very similar to the old DOS commands like DIR (directory listing) and DEL (delete file). The most common reports are also part of the Zebra Setup Utility and ZebraDesigner™ Windows driver.

Figure 3 • Memory Management Format Structure

^XA — Start Format Command

A Single Format Command is recommended
for purposes of reuse

^XZ — End Format Command

It is recommended that a single command be processed within this type of format (form). A single command is easily reused as a maintenance and development tool.

Many of the commands that transfer objects, manage and report on memory are control (~) commands. They do not need to be within a format (form). They will be processed immediately upon receipt by the printer whether in a format (form) or not. ZPL Programming for Memory Management

ZPL has various printer memory locations that are used to run the printer, assemble the print image, store formats (forms), graphics, fonts and configuration settings.

- ZPL treats Formats (Forms), Fonts, and Graphics like files; and memory locations like disk drives in the DOS operating system environment:
 - Memory Object Naming: Up to sixteen (16) alphanumeric characters followed by a three (3) alphanumeric character file extension:
i.e. 123456789ABCDEF.TTF
Legacy ZPL printers with V60.13 firmware and earlier can only use the 8.3 file name format versus today's 16.3 file name format.
- Allows moving objects between memory locations and deleting objects.
- Supports DOS directory style file list reports as printouts or status to the host.
- Allows use of 'wild cards' (*) in file access

Table 3 • Object Management and Status Report Commands

Command	Name	Description
^WD	Print Directory Label	Prints a list of objects and resident barcodes and fonts in all addressable memory locations
~WC	Print Configuration Label	Prints a configuration Status Receipt (Label) Same as Feed Button mode one flash routine
^ID	Object Delete	Deletes objects from printer memory
^TO	Transfer Object	Used to copy an object or group of objects from one memory area to another.
^CM	Change Memory Letter Designation	Reassigns a letter designation to a printer memory area.
^JB	Initialize Flash memory	Similar to formatting a disk - erases all objects from the specified memory locations B: or E:.
~JB	Reset Optional Memory	Similar to formatting a disk - erases all objects from the B: memory (factory option).
~DY	Download Objects	Downloads and installs wide variety of printer usable programming objects: fonts (OpenType and TrueType), graphics, and other object data types. Recommendation: Use ZebraNet™ Bridge for downloading graphics and fonts in the printer.
~DG	Download Graphic	Downloads an ASCII Hex representation of a graphic image. This is used by ZebraDesigner™ (label creation application) for graphics.
^FL	Font Linking	Appends secondary TrueType font or fonts to the primary TrueType font to add glyphs (characters).
^LF	List Font Links	Prints a list of the linked fonts
^CW	Font Identifier	Assigns a single alphanumeric character as an alias to a font stored in memory.



Important • Some factory installed ZPL fonts in your printer cannot be copied, cloned or restored to your printer by reloading or updating firmware. If these license restricted ZPL fonts are removed by an explicit ZPL object delete command, they must be repurchased and reinstalled via a font activation and installation utility. EPL fonts do not have this restriction.